

Breville®

Turn **on** your creativity®



Halo Rotisserie Air Fryer Oven

VDF127

product safety

READ CAREFULLY AND KEEP FOR FUTURE REFERENCE

This appliance can be used by children aged from 8 years and above and persons with reduced physical, sensory or mental capabilities or lack of experience and knowledge if they have been given supervision or instruction concerning use of the appliance in a safe way and understand the hazards involved.

Children shall not play with the appliance.

Cleaning and user maintenance shall not be made by children unless they are older than 8 and supervised.

Keep the appliance and its cord out of reach of children less than 8 years.

This product must be positioned on a stable surface with the handles positioned to avoid the spillage of hot liquids.

 Surfaces of the product are liable to get hot during use.

Never operate the product by means of an external timer or separate remote-control system.

Never immerse any part of the appliance or power cord and plug in water or any other liquid.

If the supply cord is damaged, it must be replaced by the manufacturer, its service agent or similarly qualified persons in order to avoid a hazard.

Ensure the appliance is kept clean after use. For details see the Care and Cleaning section. Pay particular care regarding items that can be immersed in water and/or a dishwasher.

- ⚠ Never use this appliance for anything other than its intended use. This appliance is for household use only. Do not use this appliance outdoors.
- ⚠ Always ensure that hands are dry before handling the plug or switching on the appliance.
- ⚠ Always use the appliance on a stable, secure, dry and level surface.
- ⚠ Ensure the appliance is switched off and unplugged from the supply socket if it is left unattended, when it is not in use or before cleaning. Never leave the appliance unattended when it is in use.
- ⚠ Never use this appliance with an external timer or separate remote-control system.
- ⚠ Always allow the appliance to fully cool down before cleaning or storing.
- ⚠ Do not use the appliance if it has been dropped, if there are any visible signs of damage or if it is leaking.
- ⚠ Never let the power cord hang over the edge of a work top, touch hot surfaces or become knotted, trapped or pinched.
- ⚠ Do not touch the external surfaces of the appliance during use as they may become very hot.
- ⚠ Only use spares or accessories that are recommended by the manufacturer.
- ⚠ Allow adequate space above and on all sides for air circulation.
- ⚠ Do not allow the appliance to touch any flammable material during use (such as curtains or wall coverings).
- ⚠ Care is required when using the appliance on surfaces that may be damaged by heat. The use of an insulated pad is recommended.

Parts

1. Left Rotisserie Holder
2. Three Air Flow Rack Positions
3. Air Flow Vent
4. Air Flow Rack
5. Removable Drip Tray
6. Removable Door
7. Light
8. Right Rotisserie Holder

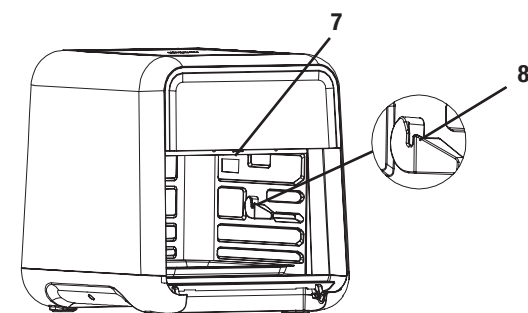
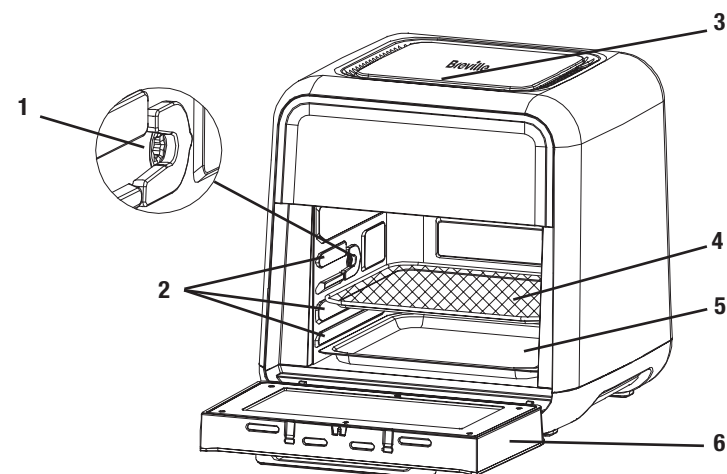

Control Panel

9. Optional Light
10. Temperature Setting
11. Timer Setting
12. Rotate
13. Start/Stop
14. Power
15. Presets: Fries, Chicken, Vegetables and Steak
16. Manual Modes: Air Fry, Bake and Dehydrate

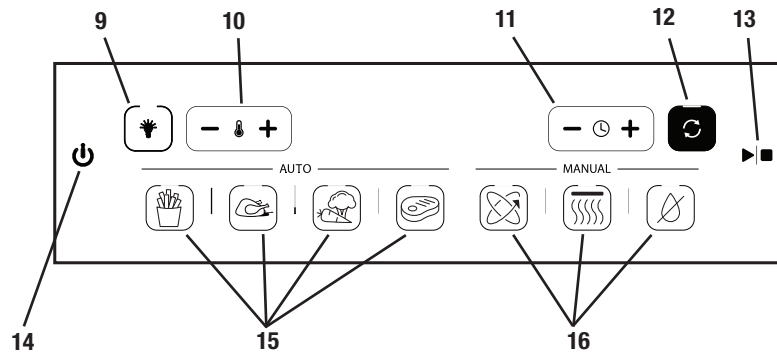

Parts & Accessories

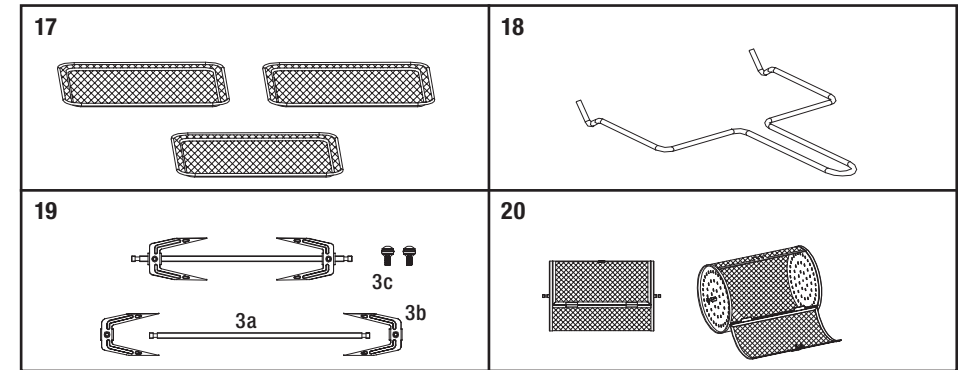

Part & Accessories

17. Air Flow Racks (3)

- Ideal for cooking a variety of foods, such as chicken breast, fish or steak
- Best accessory to use for dehydrating
- If using one Air Flow Rack place it on the top slot for more crisp results
- If using more than one Air Flow Rack switch the position of the racks throughout the cooking cycle for a more even crisp.
- When using the Air Flow racks with high sugar content food, you may find that lining each rack with a sheet of baking parchment helpful.

18. Rotisserie Handling Fork

Use the Rotisserie Handling Fork to place and remove the Rotating Mesh Basket and the Rotisserie Spit into the Rotisserie Holders.

19. Rotisserie Spit

- Ideal for cooking rotisserie chicken.
- It is advisable to secure the whole chicken with cooking string.
- To use the Rotisserie Spit, put the rod (3a) through the chicken then slide the forks (3b) down the sides of the rod and into the meat. Next, lock the forks into place using the screw set (3c) provided. Using the Rotisserie Handling Fork, place the chicken into the rotisserie holder in the unit.

20. Rotating Mesh Basket

- Ideal for cooking fries, vegetables and chicken wings, as well as roasting nuts and other snacks.
- To use the Rotating Mesh Basket, place food in the Rotating Mesh Basket then lock it. Using the Rotisserie Handling Fork, place the Rotating Mesh Basket into the Rotisserie Holders.

CAUTION: DO NOT ATTEMPT TO REMOVE BASKET WITHOUT ROTISSERIE HANDLING FORK. Please use caution while handling the basket.

21. Drip Tray (not shown)



- Used to catch oil and crumbs throughout the cooking cycle.
- Place drip tray at the bottom of the unit before beginning the cooking cycle.
- Be sure to wash the Drip Tray after every use.

USAGE INSTRUCTIONS

Preparing Your Air Fryer Oven For First Use



1. Remove all packaging materials, stickers and labels in and on the unit.
2. Wash all accessories and wipe the inside of the unit with a damp cloth.
3. Place unit on a flat surface.
4. Plug the air fryer oven into an electrical outlet.
5. Press and hold the Power button  until the unit turns on.
6. Heat Air Fryer Oven to 200°C for approximately 15 minutes to eliminate any manufacturing residue that may remain.

Manual Mode

1. Place unit on a flat surface.
2. Plug the air fryer oven into an electrical outlet.
3. Press and hold the Power button until the unit turns on.
4. Choose the desired manual mode – Air Fry, Bake or Dehydrate.
5. To set temperature and time use the plus and minus signs next to the temperature () and time () symbol then press Start () for the air fryer oven to preheat.

NOTE: Due to the heat up speed of the Breville Air Fryer Oven, food can be placed in the air fryer oven from the beginning of the preheat cycle. The cooking cycle will then automatically start when the unit has reached the desired temperature.

6. Once preheat is complete an audible alert will sound and the Ready Icon will appear on the display. If food was not placed in the Air Fryer Oven at the start of the preheat cycle open the oven door and place food inside using desired accessories then close the door to begin cooking cycle.

NOTE: When using Air Fry mode, Rotate () automatically turns on. Be sure to turn it off when cooking with the Air Flow Racks. When using Bake mode, Rotate () will need to be turned on if using the Mesh Basket or Rotisserie Spit.

7. Audible alert will sound once timer is done. Carefully remove the food with a heat safe cooking utensil or the Rotisserie Handling Fork.

NOTE: To pause cooking cycle open the door. To stop cooking cycle press Start/Stop ()

Preset Mode

1. Place unit on a flat surface.
2. Plug the air fryer oven into an electrical outlet.
3. Press and hold the Power button until the unit turns on.
4. Choose the desired Preset – Fries, Wings, Veggies or Steak. Temperature and time will automatically appear.

NOTE: Rotate automatically turns on for the Fries preset. To turn off simply press the Rotate () button.

5. Press Start () for Air Fryer Oven to preheat.

NOTE: Due to the heat up speed of the Breville Air Fryer Oven, food can be placed in the air fryer oven from the beginning of the preheat cycle. The cooking cycle will then automatically start when the unit has reached the desired temperature.

6. Once preheat is complete an audible alert will sound and the Ready Icon will appear on the display. If food was not placed in the Air Fryer Oven at the start of the preheat cycle open the oven door and place food inside using desired accessories then close the door to begin cooking cycle.

7. Audible alert will sound once timer is done. Carefully remove the food with a heat safe cooking utensil or the Rotisserie Handling Fork.

NOTE: To pause cooking cycle open the door. To stop cooking cycle press Start/Stop ()

Presets

Fries

Ideal for cooking frozen and fresh fries.

Chicken

Ideal for cooking fresh and frozen chicken pieces/drumsticks, wings etc.

Vegetables

Ideal for roasting fresh vegetables or crumbed and battered vegetables.

Steak

This preset cooks steak to medium - light pink middle. Best for steaks 1/2-1 inch thick.

Using the Rotisserie Handling Fork

To Insert the Rotating Mesh Basket or Rotisserie Spit:

1. Place the desired accessory on the Rotisserie Handling Fork.

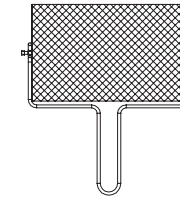

2. Insert the left side of the accessory rod into the Rotisserie Holder. Be sure the rod is engaged and in place for rotation.

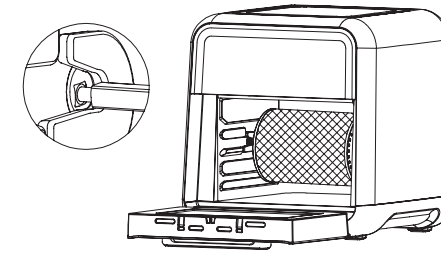

3. Place the right side of the rod onto the right Rotisserie Holder.

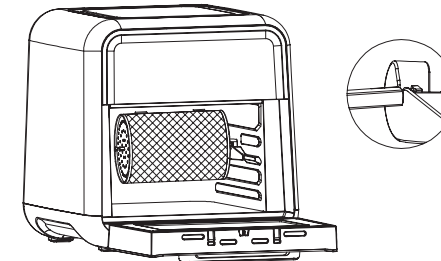

NOTE: Basket should not be able to freely rotate when it is fully engaged.

To Remove the Rotating Mesh Basket or Rotisserie Spit:

1. Insert the Rotisserie Handling Fork beneath the rod of the accessory.

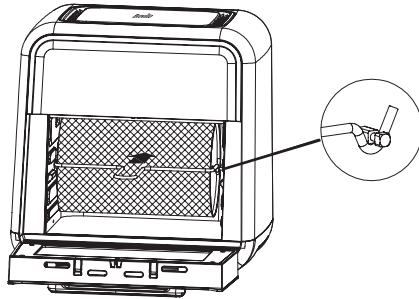

2. Lift the right side of the Rotisserie Handling Fork at an angle to remove it from the right Rotisserie Holder.

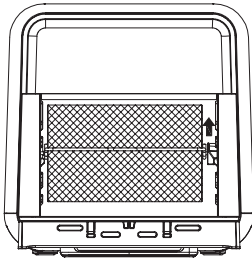

3. Then shift the Rotisserie Handling Fork to the right to allow the left side of the rod to slide out of the left Rotisserie Holder.

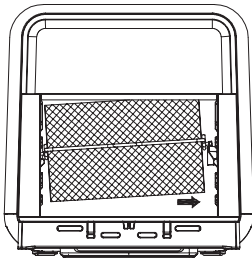

Cleaning & Maintenance For Your Air Fryer Oven

1. Clean the Air Fryer Oven and accessories after each use.
2. Before cleaning your Breville® Air Fryer Oven, unplug it and allow it to cool.
3. To clean interior of the Air Fryer Oven wipe with a damp cloth using only mild, soapy water. DO NOT IMMERSE IN WATER. Abrasive cleaners, scrubbing brushes and chemical cleaners will damage the unit.
4. Empty Drip Tray frequently to avoid accumulation of crumbs.
5. Air Flow Racks, Rotating Mesh Basket, Rotisserie Spit, Drip Tray and Rotisserie Handling Fork are dishwasher safe.
6. The Breville® Air Fryer Oven door is removable for easy cleaning. Do not immerse the door in water. Wipe clean only with mild, soapy water.

To Remove Door:

- Open the door then push the tabs at the inner bottom of the door to release.

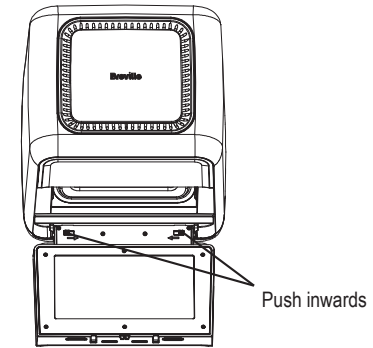

To Reassemble Door:

- Keep door at an angle while aligning the bottom of door to the unit then push the door in for it to lock in place.

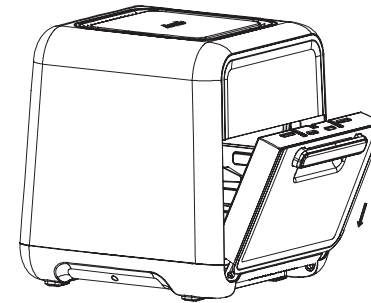

7. Store the air fryer in a dry location such as on a table or countertop or cabinet shelf.

Air Fryer Oven Cooking Chart

FOOD	WEIGHT	FUNCTION	ACCESSORY	TIME	TEMPERATURE	OIL
POTATOES						
Hand-Cut Chunky Fries	500 - 700g	Fries	Basket	35-40 mins	200°C	1 tbsp
Hand-Cut Sweet Potato Fries	500 - 600g	Fries	Air Flow Racks	30-35 mins	200°C	1 tbsp
Frozen Fries, (Thick Cut)	500 – 700g	Fries	Basket	25-30 mins	200°C	No
Frozen Fries, (Thin Cut)	500 – 700g	Fries	Basket	20 -25 mins	200°C	No
Frozen Hash Browns	600g	Fries	Air Flow Racks	18-20 mins	200°C	No
MEAT/POULTRY/FISH						
Chicken Wings	1kg	Chicken	Air Flow Racks	35 mins	180°C	No
Steak	250g (1)	Steak	Air Flow Racks	10 -15 mins	200°C	No
Pork Chops	600g (3)	Steak	Air Flow Racks	15-20 mins	180°C	1 tbsp
Beef Burgers	340g (2)	Steak	Air Flow Racks	16-18 mins	180°C	No
Whole Rotisserie Chicken	1 – 1.3kg	Air Fry	Rotisserie Spit	60 minutes	200°C	1 tbsp
Breaded Chicken Breast	340g (2)	Air Fry	Air Flow Racks	30 - 35 mins	200°C	No
Breaded Fish	350g (2)	Bake	Air Flow Racks	20 – 25 mins	180°C	No
Bacon	225g	Air Fry	Air Flow Racks	10 - 12 mins	200°C	No
Frozen Chicken Nuggets	400g	Air Fry	Air Flow Racks	12-15 mins	180°C	No
VEGETABLES						
Frozen Onion Rings	400g	Air Fry	Air Flow racks	12-15 mins	200°C	No
Fresh Roasting Vegetables	400g	Vegetables	Air Flow Racks	15-20 mins	180°C	No
DEHYDRATE						
Apples	150g	Dehydrate	Air Flow Racks	4 - 5 hours	50°C	No
Strawberries	350g	Dehydrate	Air Flow Racks	5 hours	50°C	No
Beetroots	200g	Dehydrate	Air Flow Racks	8 – 12 hours	65°C	1 tbsp
Beef Jerky	350g	Dehydrate	Air Flow Racks	4 hours	80°C	No

Recipes

Lemon and Herb Rotisserie Chicken

Serves 4

Prep time 10 minutes

Cook time 60 minutes

1-1.3kg whole chicken
1 lemon, cut into ¼'s
1 tbsp olive oil

1 tbsp dried oregano
Salt and pepper

Place the chicken onto a dinner size plate. Cut 2 lengths of kitchen string to pass underneath the bottom of the chicken widthways at one end, securing on top in a knot. Repeat at the other end of the chicken so that the legs and wings are secure. Insert the rod lengthways through the carcass of the chicken and secure at both ends with the forks.

Push the lemon pieces into the cavity of the chicken, brush all over with the oil. Dust with the oregano and seasoning.

Select Air Fry on the oven and adjust the temperature to 200°C with a time of 60 minutes. Ensure the Rotisserie icon is illuminated and allow the oven to heat.

Ensure the drip tray is inserted on the bottom of the oven to catch any fatty residue from the chicken.

Carefully place the rotisserie spit into the hot oven.

Once the cooking time has finished, allow the chicken to rest in the hot oven for a further 5 minutes before carefully removing.

Remove the Rotisserie spit and string from the chicken before carving.

Takeaway Style Salt and Pepper Chicken Wings

Serves 3-4

Prep Time 20 minutes

Cook Time 35 minutes

1 kg fresh Chicken Wings
1 tsp Chinese 5 spice
1 tbsp vegetable oil
1 medium onion, diced
1 green pepper, thinly sliced
2 red chillies, thinly sliced

2 green chillies, thinly sliced
1 tsp dried chilli flakes
1 bunch spring onions, trimmed and sliced
4 garlic cloves, finely chopped
1 tbsp sesame oil

For the salt and pepper seasoning

2 tbsp salt
¼ tsp freshly ground pepper

1 tbsp sugar
½ tsp Chinese 5 spice

Place the chicken wings in a large bowl, sprinkle over 1 generous tsp of Chinese 5 spice and rub well in, coating each wing with some of the seasoning.

Turn on the oven and select the chicken icon, adjust the temperature to 200c, time 35 minutes and allow the oven to preheat.

Spread the chicken wings out, on 2 of the Air Flow racks, inserting these into the hot oven in the top and middle position (swap over 15 minutes into the cooking time).

Ensure the drip tray is in position in the bottom of the oven to catch any drips.

Whilst these are cooking combine the salt and pepper seasoning ingredients into small bowl.

Heat a suitable sized frying pan over a medium heat, add the oil, onion and green pepper and stir fry for approx. 3-5 minutes until softened.

Add the chillies, chilli flakes, spring onions and garlic and continue cooking for a further minute, remove from the heat.

Once the chicken wings have cooked for 30 minutes, remove the trays from the oven and sprinkle the hot wings generously with the salt and pepper seasoning.

Spoon over the cooked onion and pepper mixture and return to the hot oven to finish cooking for the remaining 5 minutes.

If like your wings and spice to be extra crispy and charred, continue cooking for a further 5 minutes.

Remove the wings from the trays and drizzle with a little sesame oil.

Serve immediately with a bowl of prawn crackers.

Moroccan Cous Cous with Roasted Vegetables

Serves 4-6

Prep Time 25 minutes

Cook Time 15-20 minutes

1 red pepper, deseeded and cut into quarters
1 yellow pepper, deseeded and cut into quarters
1 large courgette, sliced
1 red onion, cut into chunks
4 tbsp olive oil
Zest and juice of 1 large lemon
1 large clove of garlic, finely chopped
1 tsp cumin
1 tsp ground coriander

½ tsp ground cinnamon
250g dried cous cous
400ml boiling water
1 tsp turmeric
400g tin chickpeas, drained and rinsed
75g raisins
15g roughly chopped coriander leaves
Small handful of mint leaves, shredded

Line one of the Air Flow racks with some foil. Place the peppers, courgette and red onion onto the foil and drizzle with 1 tbsp of olive oil. Using your hands, mix the vegetables and oil together ensuring all the pieces are coated.

Preheat the oven on the Vegetable setting, temp 200°C, time 15 minutes. Place the vegetables into the hot oven, turning half way through cooking to ensure even browning.

Whilst the vegetables are cooking, mix the remaining olive oil, lemon zest and juice, garlic, cumin, coriander and cinnamon in a small bowl and set aside.

Place the cous cous into a heatproof bowl, add the boiling water and turmeric, mix well and cover for approx. 5 minutes.

Remove the vegetables from the oven and allow to cool.

Once cool enough to handle cut into bite sized pieces.

Stir the lemony oil into the cous cous, along with the remaining ingredients, add the cooked vegetables, mix well and adjust the seasoning.

Will keep for approx. 2 days in a refrigerator in a covered container.

Steak with Chimichurri Dressing

Serves 2

Prep Time 15 minutes

Cook Time 10 minutes, medium rare.

For this recipe you will need a small food processor or mini chopper to prepare the chimichurri.

2 sirloin steaks approx. 225-250g weight per steak
1 tsp vegetable oil

Freshly ground black pepper

Dressing

Small bunch parsley leaves picked
2 garlic cloves, peeled
1 shallot, quartered
½ tsp chilli flakes

2½ tbsp extra virgin olive oil
Juice of ½ lemon
2 tsp red wine vinegar

Remove your steak from its packaging and allow to sit at room temperature for approx. 30 minutes to 1 hour before cooking.

Preheat your oven on the Steak setting, 200°C, time 10 minutes.

Brush the steak both sides with the oil and add a dusting of freshly ground black pepper.

Place both steaks onto one of the Air Flow racks, ensuring the drip tray at the bottom of the oven is in place to catch any drips.

Insert the tray into the top position of the oven and allow to cook for 10 minutes.

Place all the dressing ingredients into your mini food processor and blend until the parsley is chopped.

Remove the steak from the oven, place onto a warm plate and allow to rest for approx. 5 minutes.

Carve the steak on the diagonal, serving the chimichurri on the side.

Helpful Tips / Troubleshooting

PROBLEM	POTENTIAL CAUSE	SOLUTION
Overcooked / Undercooked Foods	<ul style="list-style-type: none"> Incorrect temperature or time setting 	<ul style="list-style-type: none"> You may have to adjust the time and temperature to desired taste. Because your Air Fryer Oven is smaller than your regular oven, it will heat up faster and generally cook in shorter periods of time.
	<ul style="list-style-type: none"> Rack placement 	<ul style="list-style-type: none"> Refer to "Positioning Air Flow Racks" Section, Page 5. Rack may need to be adjusted to accommodate food type.
Burning Smell	<ul style="list-style-type: none"> Food build-up inside oven, on heating elements or in crumb tray 	<ul style="list-style-type: none"> Refer to "Cleaning Your Air Fryer Oven" Section, Page 9.
Heating elements do not stay ON	<ul style="list-style-type: none"> Heating elements will cycle ON and OFF to maintain proper heat You may not see elements glowing 	<ul style="list-style-type: none"> Allow oven to reach set temperature prior to inserting food. Oven will indicate when preheat is complete.
Touch panel interface is non-responsive	<ul style="list-style-type: none"> Panel is dirty or greasy Excess moisture on panel Controller is malfunctioning 	<ul style="list-style-type: none"> Ensure panel is clean and free of debris before using. Ensure panel is clean and dry, and use dry hands to operate. Unplug unit and let it rest for 60 seconds before plugging in.
Small water drips from door during cooking	<ul style="list-style-type: none"> Water released from food during the cooking cycle 	<ul style="list-style-type: none"> This is not a concern and is part of the normal cooking cycle. Please mop up drips with a soft cloth.

Fitting of a plug - for U.K. and Ireland only

⚠ This appliance must be earthed.

If the plug is not suitable for the socket outlets in your home, it can be removed and replaced by a plug of the correct type.

If the fuse in a moulded plug needs to be changed, the fuse cover must be refitted. The appliance must not be used without the fuse cover fitted.

If the plug fuse requires replacement, a fuse of the same rating as that fitted by the manufacturer must be used. In order to prevent a hazard do not fit a fuse of a lower or higher rating.

If the terminals in the plug are not marked or if you are unsure about the installation of the plug please contact a qualified electrician.

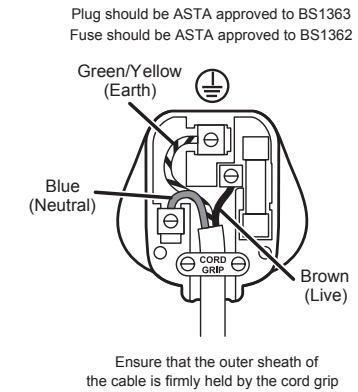

After sales service & replacement parts

In the case the appliance does not operate but is under warranty, return the product to the place it was purchased for a replacement. Please be aware that a valid form of proof of purchase will be required. For additional support, please contact our Consumer Service Department at 0800 028 7154 or email: BrevilleEurope@newellco.com.

Waste Disposal

Waste electrical products should not be disposed of with household waste. Please recycle where facilities exist. E-mail us at BrevilleEurope@newellco.com for further recycling and WEEE information.





Breville®

Jarden Consumer Solutions (Europe) Limited
5400 Lakeside, Cheadle Royal Business Park,
Cheadle, SK8 3GQ, United Kingdom

Newell Poland Services Sp. z o.o.,
Plac Andersa 7, Poznan, 61-894, Poland.

e-mail: BrevilleEurope@newellco.com
UK Telephone: 0800 028 7154



CE

© 2021 Jarden Consumer Solutions (Europe) Limited. All rights reserved.
Jarden Consumer Solutions (Europe) Limited, 5400 Lakeside, Cheadle Royal Business Park, Cheadle, Cheshire, SK8 3GQ, United Kingdom.
Newell Poland Services Sp. z o.o., Plac Andersa 7, Poznan, 61-894, Poland.
Jarden Consumer Solutions (Europe) Limited and Newell Poland Services Sp. z o.o. are subsidiaries of Newell Brands Inc.
The product you buy may differ slightly from the one shown on this carton due to continuing product development.
Made in China.