

# Specification

Power supply	230–240 V ~ 50 Hz		
Power consumed	505–550 W		
Capacity	(Strong flour for a loaf) (Strong flour for a dough) (Yeast)	max. 600 g max. 600 g max. 8 g	min. 400 g min. 250 g min. 0.75 g
Capacity of raisin nut dispenser	max. 150 g dried fruit/nuts		
Timer	Digital timer (up to 13 hours)		
Dimensions (H × W × D)	(SD-2501) approx. 38.2 × 25.6 × 38.9 cm (SD-2500) approx. 36.2 × 25.6 × 38.9 cm		
Weight	(SD-2501) approx. 7.0 kg (SD-2500) approx. 6.5 kg		
Accessories	Measuring cup, measuring spoon		

## Information on Disposal for Users of Waste Electrical & Electronic Equipment (private households)



This symbol on the products and/or accompanying documents means that used electrical and electronic products should not be mixed with general household waste.

For proper treatment, recovery and recycling, please take these products to designated collection points, where they will be accepted on a free of charge basis. Alternatively, in some countries you may be able to return your products to your local retailer upon the purchase of an equivalent new product.

Disposing of this product correctly will help to save valuable resources and prevent any potential negative effects on human health and the environment which could otherwise arise from inappropriate waste handling.

Please contact your local authority for further details of your nearest designated collection point.

Penalties may be applicable for incorrect disposal of this waste, in accordance with national legislation.

## Information on Disposal in other Countries outside the European Union

This symbol is only valid in the European Union.

If you wish to discard this product, please contact your local authorities or dealer and ask for the correct method of disposal.

**Panasonic Test and Development Kitchen**  
**Panasonic Consumer Electronics U.K.**  
**A Division of Panasonic U.K. Ltd**  
Willoughby Road, Bracknell, Berks, RG12 8FP

Importer's name & address pursuant to the EU GPSD directive 2001/95/EC/Art.5

**Panasonic Marketing Europe GmbH**  
Hagenauer Str.43 65203 Wiesbaden F.R.GERMANY

**Panasonic Corporation**

Web Site: <http://www.panasonic.co.uk/>

DZ50E166  
F0211S0



Printed in China

# Panasonic®

## Automatic Bread Maker

OPERATING INSTRUCTIONS AND RECIPES (Household Use)

Model No. **SD-2501/SD-2500**



SD-2501

Before Use

How to Use

Recipes

How to Clean

Troubleshooting

Thank you for purchasing this Panasonic product.

- Please read these instructions carefully before using this product and save this manual for future use.
- These operating instructions are intended to be used for two different models. The explanations inside mainly focus on the SD-2501 model. (See P. 2 for the differences in functions between the two)
- This product is intended for household use only.

# Contents

## Before Use

- Safety Instructions ..... 3
- Accessories/Parts Identification ..... 6
- Bread-making Ingredients ..... 8

## How to Use

- List of Bread Types and Baking Options ..... 10
- Baking Bread ..... 12
- When adding extra ingredients ..... 14
- Baking Brioche ..... 15
- Making Dough ..... 16
- Making Brioche Dough ..... 17
- Baking Cakes ..... 18
- Making Jam ..... 19
- Making Compote ..... 20

## Recipes

- Recipe Contents ..... 21
- **Recipes** ..... **22–41**

## How to Clean

- Care & Cleaning ..... 42

## To Protect the Non-stick Finish

- To protect the non-stick finish ..... 43

## Troubleshooting

- Troubleshooting ..... 44

# Safety Instructions Please make sure to follow these instructions.

In order to prevent accidents or injuries to the user, other people, and damage to property, please follow the instructions below.







■ **The following charts indicate the degree of damage caused by wrong operation.**

 <b>Warning:</b> Indicates serious injury or death.	 <b>Caution:</b> Indicates risk of injury or property damage.
--	--

■ **The symbols are classified and explained as follows.**

 This symbol indicates prohibition.	 This symbol indicates requirement that must be followed.
--	--

## **Warning**

- 
**Do not use the appliance if the power cord or power plug is damaged or the power plug is loosely connected to the power outlet.**  
 (It may cause an electric shock, or fire due to short circuit.)  
 → If the supply cord is damaged, it must be replaced by the manufacturer, its service agent or similarly qualified person in order to avoid a hazard.
  
- 
**Do not damage the power cord or power plug.**  
 (It may cause an electric shock, or fire due to short circuit.)  
 Following actions are strictly prohibited. (Modifying, placing near heating elements, bending, twisting, pulling, putting heavy objects on top, and bundling the cord.)
  
- 
**Do not plug or unplug the power cord with wet hands.**  
 (It may cause an electric shock.)
  
- 
**Do not exceed voltage on the outlet and do not use alternate current other than listed on the appliance.**  
 (It may cause an electric shock or fire.)
  - Make sure the voltage supplied to the appliance is the same as your local supply.
  - Plugging other devices into the same outlet may cause an electric overheating.
  
- 
**Insert the power plug firmly.**  
 (Otherwise it may cause an electric shock and fire caused by the heat that may generate around the plug.)
  
- 
**Clean the power plug regularly.**  
 (A soiled power plug may cause insufficient insulation due to the moisture and lint build-up, which may cause a fire.)  
 → Unplug the power plug, and wipe with the dry cloth.

**These instructions are for two different Bread Maker models**

■ **SD-2501**

Raisin nut dispenser





If using dried fruit such as raisins, nuts, or seeds, these are added automatically. (P. 14)

■ **SD-2500**

Additional ingredients should be added manually when the beep sounds. (P. 14)



- The photographs and illustrations in this manual are of the SD-2501 model.

# Safety Instructions

## Warning

- ! Discontinue using the appliance immediately and unplug in the unlikely event that this appliance stops working properly.**  
(It may cause smoking, fire, electric shock or burn.)  
e.g. for abnormal or breaking down
  - The power plug and the power cord become abnormally hot.
  - The power cord is damaged or power failure.
  - The main body is deformed or is abnormally hot.
  - The appliance makes abnormal turning noise during use.→ Unplug the appliance immediately and consult a Panasonic dealer and have it serviced by an authorized technician.
- ⊘ Do not touch, block or cover the steam vent holes during use.**  
(It may cause a burn.)
  - Especially pay attention for children.
- ⊘ Do not disassemble, repair or modify this appliance.**  
(It may cause a fire, electric shock or injury.)  
→ Consult a Panasonic dealer and have it serviced by an authorized technician.
- ⊘ Do not immerse the appliance in water or splash it with water.**  
(It may cause an electric shock, or catch a fire due to short circuit.)
- ! This appliance is not intended for use by persons (including children) with reduced physical, sensory or mental capabilities, or lack of experience and knowledge, unless they have been given supervision or instruction concerning use of the appliance by a person responsible for their safety. Children should be supervised to ensure that they do not play with the appliance.**  
(It may cause a burn, injury or electric shock.)

## Caution

- ! Make sure to hold the power plug when unplugging the power plug.**  
(Otherwise it may cause an electric shock, or fire due to short circuit.)
- ! Unplug the power plug when the appliance is not in use.**  
(Otherwise it may cause an electric shock, or fire due to electric leakage.)
- ! Please unplug and allow the appliance to cool down before cleaning it.**  
(It may cause a burn.)
- ⊘ Do not allow the power cord to hang over the edge of the table or touch a hot surface.**  
(It may cause a burn or injury.)
- ⊘ Do not remove the bread pan or unplug the Bread Maker during use.**  
(It may cause a burn or injury.)

## Caution

- ⊘ Do not use the appliance on following places.**
  - Position the Bread Maker on a firm, dry, clean, flat heatproof worktop at least 10 cm (4 inches) from the edge of the worktop.  
(It may cause the appliance to slip and fall from the worktop.)
  - Do not place on unstable surfaces, on electrical appliances such as a refrigerator, on materials such as tablecloths or on carpet, etc.  
(It may cause falling or a fire.)
  - During baking the unit heats up. The Bread Maker should be placed at least 5 cm (2 inches) from adjacent walls and other objects.  
(It may cause a discoloration or deformation.)
- ⊘ Do not touch hot area such as bread pan, inside of unit, heating element or inside of the lid while the appliance is in use or after cooking.**  
**The temperature of accessible surfaces may be high when the appliance is operating.**  
(It may cause a burn.)  
→ To avoid burns, always use oven gloves when removing the bread pan or the finished bread.  
(Do not use wet oven gloves.)  
Also take care when removing the finished bread or kneading blade.

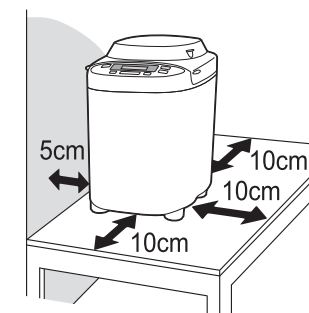

## Important Information

- Do not use the appliance outdoors, in the immediate vicinity of heat sources or in rooms of high humidity.  
(It may cause a malfunction or deformation.)
- Do not use excessive force on the parts as is illustrated on the right.  
(It may cause a malfunction or deformation.)
- This appliance is not intended to be operated by means of an external timer or separate remote-control system.

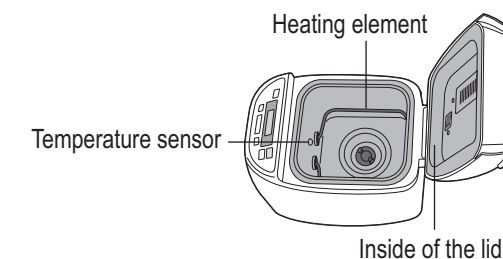

## Electrical Requirement

### FOR YOUR SAFETY PLEASE READ THE FOLLOWING TEXT CAREFULLY.

This appliance is supplied with a moulded three pin mains plug for your safety and convenience.

A 13-amp fuse is fitted in this plug.

Should the fuse need to be replaced please ensure that the replacement fuse has a rating of 13 amps and that it is approved by ASTA or BSI to BS1362.

Check for the ASTA mark  or the BSI mark  on the body of the fuse.

If the plug contains a removable fuse cover you must ensure that it is refitted when the fuse is replaced.

If you lose the fuse cover the plug must not be used until a replacement cover is obtained.

A replacement fuse cover can be purchased from your local Panasonic Dealer.

IF THE FITTED MOULDED PLUG IS UNSUITABLE FOR THE SOCKET OUTLET IN YOUR HOME, THEN THE FUSE SHOULD BE REMOVED AND THE PLUG CUT OFF AND DISPOSED OF SAFELY.

THERE IS A DANGER OF SEVERE ELECTRICAL SHOCK IF THE CUT OFF PLUG IS INSERTED INTO ANY 13-AMP SOCKET.

# Accessories/Parts Identification

Main Unit

Control Panel

## Raisin nut dispenser (SD-2501 only)

The ingredients placed in the raisin nut dispenser will drop into the bread pan automatically upon selecting the menu with raisin (03, 06, 14, 17, 19 and 25).

Turn to P. 14 for ingredients which may be placed in the raisin nut dispenser. Never operate the Bread Maker without the dispenser being in place.



Raisin nut dispenser flap (SD-2501 only)  
Lid



## Accessories

**Measuring cup**  
To measure out liquids

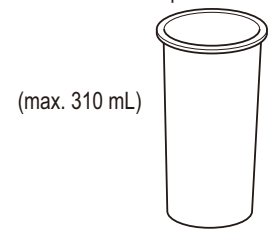

(max. 310 mL)  
•10 mL increments

**Measuring spoon**  
To measure out sugar, salt, yeast, etc.

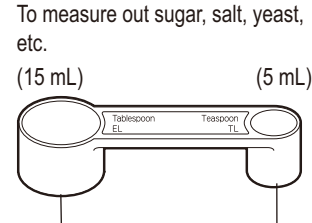

(15 mL) (5 mL)  
Tablespoon •½ marking  
Teaspoon •¼, ½, ¾ markings

## Operation status

- : displayed for the current stage of the program. Ingredients are being regulated on the 'Rest' stage before kneading.
- ⚡: displayed when there has been an interruption in the power supply.
- 👤: (SD-2501) displayed when adding ingredients manually on menu 11 and 23. (SD-2500) displayed when the menu with extra ingredients are added manually is chosen.

## Time remaining until program finished

Also when adding ingredients manually, display will show the time until adding extra ingredients in the program.

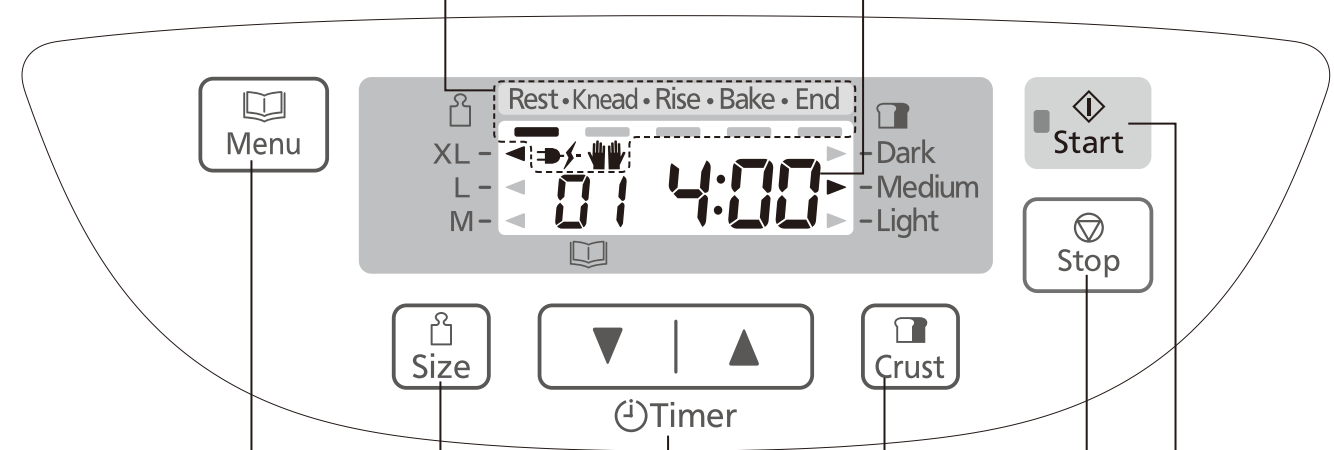

## Menu

Press this pad to choose menu. Menu number will display and each time this pad is pressed, menu number will change to the next choice. (Hold the pad to advance more quickly) See P. 10 and 11 for menu number.

## Size

Press this pad to choose size. See P. 10 for available menu.

- XL
- L
- M

## Timer

Set delay timer (time until bread is ready) or set the baking/cooking time for menu 15, 26 and 27 (SD-2500: 14, 24 and 25).  
'▲' Press this pad to increase the time.  
'▼' Press this pad to decrease the time.

## Crust

Press this pad to choose crust colour. See P. 10 for available menu.

- Dark
- Medium
- Light

## Start

The start light will flash during program selection. Press the start pad when programming is completed. When the start pad is pressed, the start light will stop flashing and become constant.

## Stop

If you wish to change the program, you must stop the operation by holding down the stop pad for more than 1 second. The start light will go off. Then re-program accordingly.

This picture shows all words and symbols, but during operation only those relevant will be displayed.

Before Use

# Bread-making Ingredients

## Flour

Main ingredient of bread. The protein in flour forms gluten during kneading. Gluten provides structure and texture and helps the bread to rise.

- Use strong bread flour only.
- Flour must be weighed on scales.

## Dairy Products

Add flavour and nutritional value.

- If you use milk instead of water, the nutritional value of the bread will be higher, but do not use in timer setting as it may not keep fresh overnight.
- Reduce the amount of water proportionally to the amount of milk.

## Yeast

Enables the bread to rise.

- Yeast which has 'Easy Blend', 'Fast Action' or 'Easy Bake' written on the packet is recommended.
- Do not use dried yeast that requires preliminary fermentation.
- When using yeast from sachets, seal the sachet again immediately after use. To store follow manufacturers instructions but use opened individual sachets within 48 hours.



## Water

- Use normal tap water.
- Use tepid water if using menu 02, 05, 07, 12 or 20 (SD-2500: 02, 05 or 11) in a cold room.
- Use chilled water if using menu 07, 08, 11, 13, 14, 20, 21, 23, 24 or 25 (SD-2500: 07, 10, 12, 13, 19, 21, 22 or 23) in a hot room.
- Always measure out liquids using the measuring cup provided.

## Salt

Improves the flavour and strengthens gluten to help the bread rise.

- The bread may lose size/flavour if measuring is inaccurate.

## Fat

Adds flavour and softness to the bread.

- Use butter, margarine or oil. 2 tbsps oil are equivalent to 25 g butter.

**Sugar** (granulated sugar, brown sugar, honey, treacle etc)  
Adds softness and gives crust colour.

■ You can make your bread taste better by adding other ingredients:

Eggs	Improve the nutritional value and colouring of the bread. (Water amount must be reduced proportionally) Beat eggs when adding eggs.
Bran	Increases the bread's fibre content. • Use max. 50 g (2 oz).
Wheat germ	Gives the bread a nuttier flavour. • Use max. 50 g (2 oz).
Spices, herbs	Enhance the flavour of the bread. • Only use a small amount (1–2 tsp).

## Main Flours Used in Bread

Strong flour is milled from hard wheat and has a high content of protein which is necessary for the development of gluten. Carbon dioxide produced during fermentation is trapped within the elastic network of gluten, thus making the dough rise.

### White flour:

Made by grinding wheat kernel, excluding bran and germ. Used in e.g. menu 01, 08, 16 or 21 (SD-2500: 01, 07, 15 or 19).

- Always use strong flour when using the recipes in this book.
- Do NOT use plain or self-raising flour as a substitute for bread flour.

### Wholemeal flour:

Made by grinding entire wheat kernel, including bran and germ.

Makes bread rich in minerals, but lower in height and denser than bread baked with white flour because the gluten strands are cut by the edges of bran flakes and germ.

### Rye flour:

Contains some proteins, but these do not produce as much gluten as wheat flour.

Makes dense, heavy bread with a flat or slightly sunken top crust (use in menu 07 or 20). (SD-2501 only)

- Do not use more than stated quantity, 100 g maximum rye out of 500 g flour in SD-2500.

### Spelt flour:

In the wheat family but is a completely different species genetically.

Although it contains gluten some gluten-intolerant people can digest it. (Consult your doctor.)

Makes loaves with a flat/slightly sunken crust.

Spelt wholegrain flour bread becomes low height and dense compare with spelt white flour bread.

We will recommend spelt white flour to be used more than the half of the entire flour.

- There is Spelt (*Triticum spelta*) suitable for baking bread and Einkorn wheat (*Triticum monococcum*: also it is called small spelt) which is not suitable for baking bread are sold as spelt. Please use spelt. [use in menu 13, 14, 24 or 25 (SD-2500: 12, 13, 22 or 23)]

**Brown flour:** 10–15% of wheat grain removed during milling.

### Softgrain flour:

Strong white flour with wheat and rye grains added. Provides extra fibre, texture, and flavour.

- Do not use with 'Timer' option (grains can absorb water and swell up, spoiling texture of loaf).

### Granary® or Malted Grain flour:

Has crushed wheat or rye grains added together with malted whole wheat.

Makes brown bread coarser and moister with nuttier flavour.

- Do not use more than stated quantity (could damage the bread pan's non-stick finish).

### Stoneground flour:

Grains are crushed between two large millstones rather than with steel rollers.

- Do not use more than stated quantity (could damage the bread pan's non-stick finish, or overload motor).

### Other flour:

Products milled from other grains (i.e. corn meal, rice, millet, soy, oat, buckwheat, barley flours).

- Do not use more than stated quantity (hinders rising and texture).
- Should not be used as substitute for bread flour.
- Gluten Free - see P. 28.

- Coarse ingredients such as flours with whole grains or the addition of nuts and seeds may damage the bread pan's non-stick finish.

## If using a bread mix...

### ■ Bread mixes including yeast

- ① Place a 500 g mix in the bread pan, then add water. (Follow instructions on the packet for the quantity of water)
- ② Select menu 02– 'Large' size setting.

- With some mixes, it is not clear how much yeast is included, so results may vary.

### ■ Baking brioche with brioche mix

- Select menu 11 (SD-2500: 10) or 02 – 'Medium' size – 'Light' crust colour.

### ■ Bread mix with separate yeast sachet

- ① First place the measured yeast in the bread pan, then the bread mix, then the water.
  - Bread Maker Capacity  
400–600 g mix (for a loaf), 250–600 g mix (for a dough)
- ② Set the machine according to the type of flour included in the mix, and start the baking.
  - White flour, brown flour → menu 01
  - Whole wheat, multi grain flour → menu 04
  - rye flour → menu 07 (SD-2501 only)

# List of Bread Types and Baking Options

## ■ Function Availability and Time Required

• Time required for each process will differ according to room temperature.

			Options			Processes				
Menu Number		Menu	Size	Crust	Timer	Rest	Knead	Rise	Bake	Total
SD-2501	SD-2500									
01	01	Basic	●	●	●	30 min–60 min	15–30 min*4	1 hr 50 min–2 hr 20 min	50–55 min	4 hr–4 hr 5 min
02	02	Basic Rapid	●	●	—	—	15–20 min	approx. 1 hour	35–40 min	1 hr 55 min–2 hr
03	03	Basic Raisin	●	●*1	●*3	30 min–60 min	15–30 min*4	1 hr 50 min–2 hr 20 min	50 min	4 hours
04	04	Whole wheat	●	—	●	1 hr–1 hr 40 min	15–25 min*4	2 hr 10 min–2 hr 50 min	50 min	5 hours
05	05	Whole wheat Rapid	●	—	—	15 min–25 min	15–25 min*4	1 hr 30 min–1 hr 40 min	45 min	3 hours
06	06	Whole wheat Raisin	●	—	●*3	1 hr–1 hr 40 min	15–25 min*4	2 hr 10 min–2 hr 50 min	50 min	5 hours
07	—	Rye	—	—	●	45 min–60 min	approx. 10 min	1 hr 20 min–1 hr 35 min	1 hour	3 hr 30 min
08	07	French	—	—	●	40 min–2 hr 5 min	10–20 min	2 hr 45 min–4 hr 10 min	55 min	6 hours
09	08	Italian	—	—	●	30 min–1 hr	10–15 min	2 hr 25 min–3 hr	50 min	4 hr 30 min
10	09	Sandwich	—	—	●	1 hr–1 hr 40 min	15–25 min*4	2 hr 10 min–2 hr 50 min	50 min	5 hours
11	10	Brioche	—	●*1	—	30 min	25–45 min*4	1 hr 25 min	50 min	3 hr 30 min
12	11	Gluten Free	—	●*2	—	—	15–20 min	40–45 min	50–55 min	1 hr 50 min–1 hr 55 min
13	12	Speciality	●	—	●	30 min–1 hr 15 min	15–30 min*4	1 hr 50 min–2 hr 45 min	55 min	4 hr 30 min
14	13	Speciality Raisin	●	—	●*3	30 min–1 hr 15 min	15–30 min*4	1 hr 50 min–2 hr 45 min	55 min	4 hr 30 min
15	14	Bake only	—	—	—	—	—	—	30 min–1 hr 30 min	30 min–1 hr 30 min

\*1 Only 'Light' or 'Medium' available. \*2 Only 'Medium' or 'Dark' available. \*3 The timer can only be used on the SD-2501.

\*4 There is a period of rise during the knead period.

• The Bread Maker will operate for a short time during the rise period (to ensure optimal gluten development).

			Options			Processes				
Menu Number		Menu	Size	Crust	Timer	Rest	Knead	Rise	Bake	Total
SD-2501	SD-2500									
16	15	Basic	—	—	—	30 min–50 min	15–30 min*4	1 hr 10 min–1 hr 30 min	—	2 hr 20 min
17	16	Basic Raisin	—	—	—	30 min–50 min	15–30 min*4	1 hr 10 min–1 hr 30 min	—	2 hr 20 min
18	17	Whole wheat	—	—	—	55 min–1 hr 25 min	15–25 min*4	1 hr 30 min–2 hr	—	3 hr 15 min
19	18	Whole wheat Raisin	—	—	—	55 min–1 hr 25 min	15–25 min*4	1 hr 30 min–2 hr	—	3 hr 15 min
20	—	Rye	—	—	—	45 min–60 min	approx. 10 min	—	—	2 hours
21	19	French	—	—	—	40 min–1 hr 45 min	10–20 min	1 hr 35 min–2 hr 40 min	—	3 hr 35 min
22	20	Pizza	—	—	●	(Knead) 10–18 min	(Rise) 7–15 min	(Knead) approx. 10 min	(Rise) approx. 10 min	45 min
23	21	Brioche	—	—	—	30 min	25–45 min*4	35 min	—	1 hr 50 min
24	22	Speciality	—	—	—	30 min–1 hr 5 min	15–30 min*4	1 hr 10 min–1 hr 55 min	—	2 hr 45 min
25	23	Speciality Raisin	—	—	—	30 min–1 hr 5 min	15–30 min*4	1 hr 10 min–1 hr 55 min	—	2 hr 45 min
26	24	Jam	—	—	—	—	—	—	—	1 hr 30 min–2 hr 30 min
27	25	Compote	—	—	—	—	—	—	—	1 hr–1 hr 40 min

Dough

How to Use

# Baking Bread

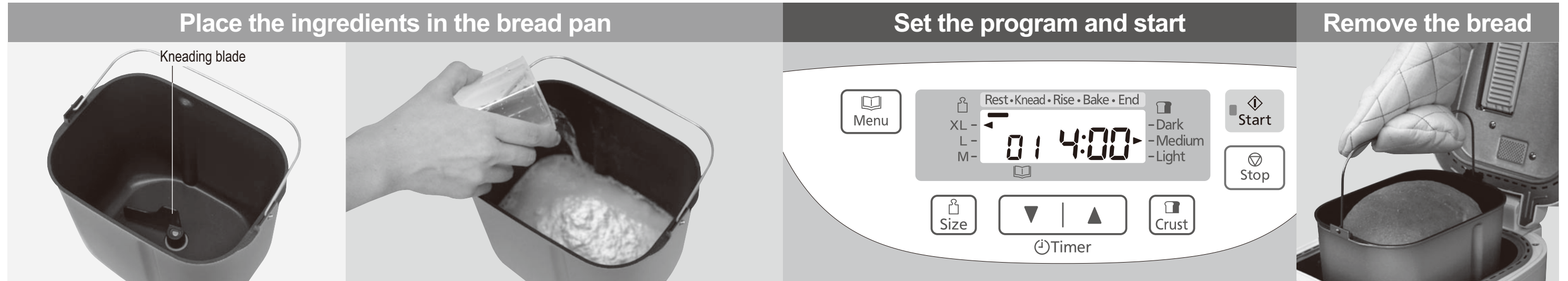

## 1 Remove the bread pan and set the kneading blade

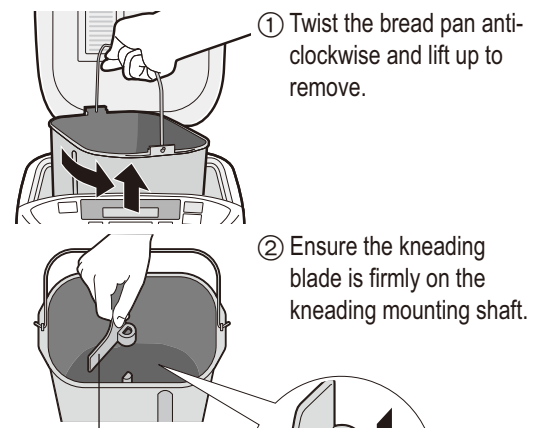

① Twist the bread pan anti-clockwise and lift up to remove.

② Ensure the kneading blade is firmly on the kneading mounting shaft.

- Ensure that the shaft and kneading blade are clean, see P. 42 for cleaning.
- Use the specified kneading blade when baking rye bread. (SD-2501 only)
- The kneading blade is designed to fit loosely on the shaft.

■ Baking bread with added ingredients (P. 14) (SD-2501 only)

Clean and dry beforehand

## 2 Place the measured ingredients in the bread pan

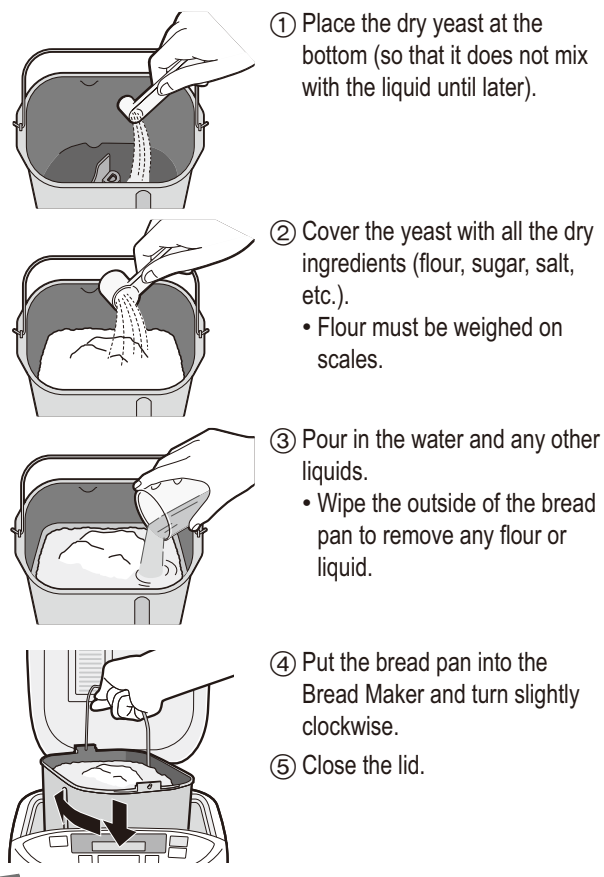

① Place the dry yeast at the bottom (so that it does not mix with the liquid until later).

② Cover the yeast with all the dry ingredients (flour, sugar, salt, etc.).  
• Flour must be weighed on scales.

③ Pour in the water and any other liquids.  
• Wipe the outside of the bread pan to remove any flour or liquid.

④ Put the bread pan into the Bread Maker and turn slightly clockwise.

⑤ Close the lid.

## 3 Plug the Bread Maker into a 230–240V socket

- For optimum results, don't open the lid until bread is complete as it affects bread quality.
- Make sure the start light is off before selecting a program.

## 4 Select a bake menu

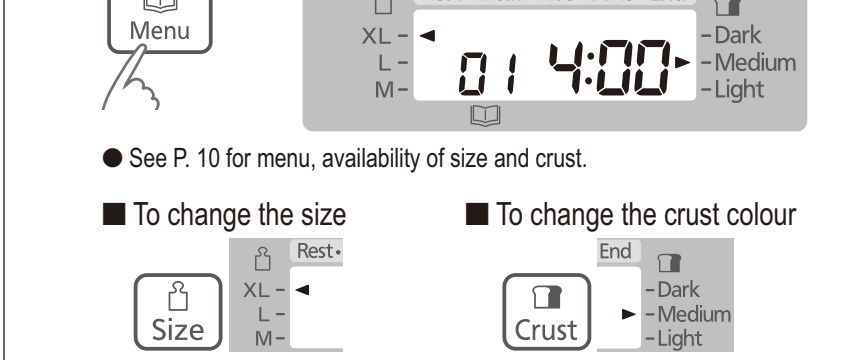

- See P. 10 for menu, availability of size and crust.
- To change the size
- To change the crust colour

■ To set the timer →  
e.g. It is 9:00 PM now, and you want the bread to be ready at 6:30 the next morning.  
→ Set the timer to '9:30' (9 hours 30 minutes from now).

• Pressing the button once will advance the timer by 10 minutes (hold to advance more quickly).

## 5 Press Start pad to start the machine

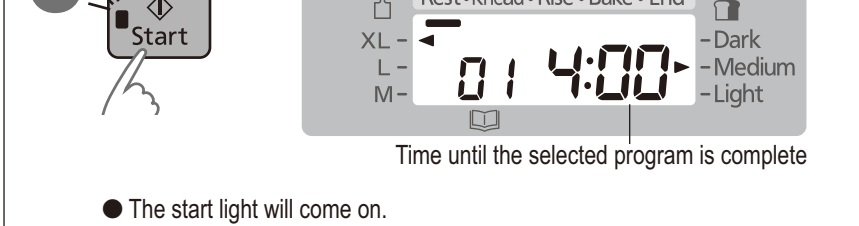

- The start light will come on.

## 6 Press Stop pad and remove bread

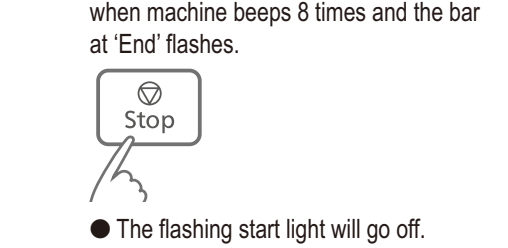

- when machine beeps 8 times and the bar at 'End' flashes.
- The flashing start light will go off.

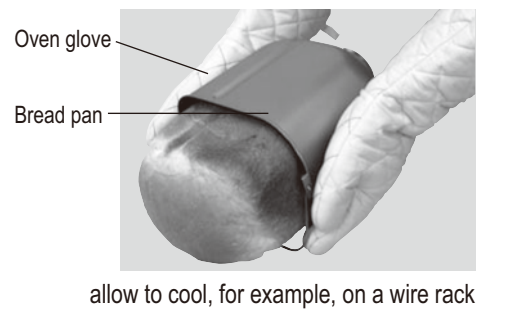

## 8 Unplug after use

- The Bread Maker has a keep warm facility to reduce condensation of steam within the loaf which operates if the stop pad is not pressed on completion of the program.
- However, this will accelerate the browning of the crust, therefore, upon completion of baking, switch off the unit, remove the bread immediately from the unit to cool it.
- If you leave the bread to cool down in the bread pan, moisture will be retained within the loaf which will affect the finished quality of the loaf. Therefore, cool on a wire rack to ensure optimum quality of the loaf.

# When adding extra ingredients

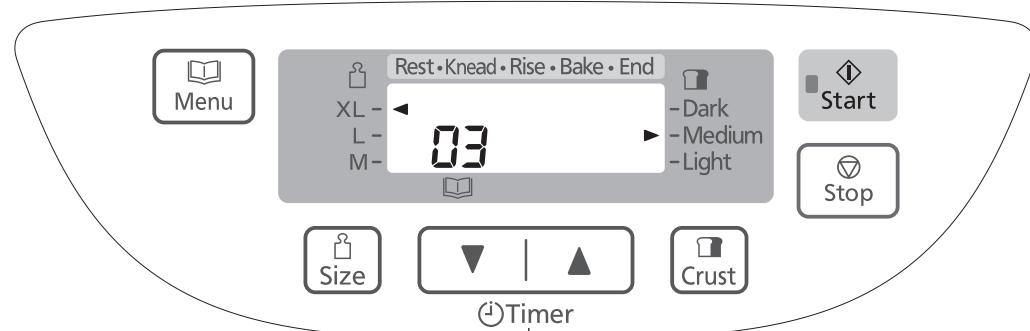

Press this pad when display indicates minutes until ingredient is added, to see how long to wait until the selection of program is complete. (SD-2500 only)

## Adding extra ingredients to bread or dough

By selecting a menu number below, you can mix your favourite ingredients into the dough to make all kinds of flavoured breads.  
 (SD-2501) 03, 06, 14, 17, 19, 25  
 (SD-2500) 03, 06, 13, 16, 18, 23

### SD-2501 (with raisin nut dispenser)

Simply place the extra ingredients in the dispenser or the bread pan before start

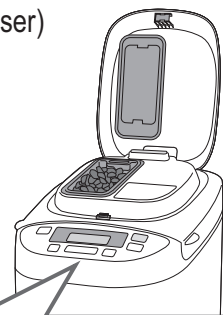

### SD-2500 (no raisin nut dispenser)

Wait until the beeper sounds before placing the ingredients in the bread pan



### Dry ingredients, insoluble ingredients

→ Place the extra ingredients in the raisin nut dispenser and set the machine.



- Dried fruits**
- Cut up roughly into approx. 5mm cubes.
  - Sugar-coated ingredients may stick to the raisin nut dispenser and not fall into the bread pan.

- Nuts**
- Chop finely.
  - Nuts impair the effect of gluten, so avoid using too much.

- Seeds**
- Using large, hard seeds may scratch the coating of the dispenser and bread pan.

- Herbs**
- Use up to 1–2 tbsp of dried herbs. For fresh herbs, follow the instructions in the recipe.

- Bacon, salami**
- Sometimes oily ingredients may stick to the raisin nut dispenser and not fall into the bread pan.

### Moist/viscous ingredients, soluble ingredients\*

→ Place these ingredients together with the others into the bread pan.



- Fresh fruits, fruits pickled in alcohol**
- Only use quantities as in the recipe, as the water content of the ingredients will affect your bread.

### Cheese, chocolate



\* These ingredients cannot be placed in the raisin nut dispenser as they would stick to it and not fall into the bread pan.

\* Follow the recipe for the quantities for each ingredient.

# Baking Brioche

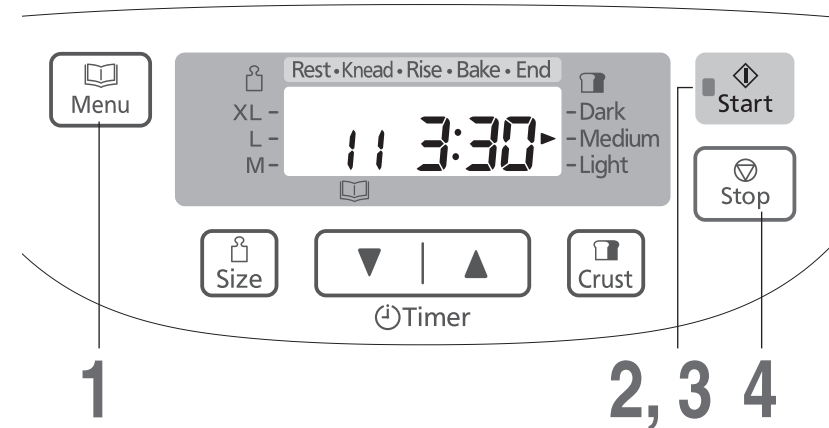

Preparation (P. 12)

- ① Cut the butter for adding later into 1–2 cm cubes and keep them in fridge.
- ② Put the kneading blade into the bread pan.
- ③ Place the ingredients in the bread pan in the order listed in the recipe.
- ④ Set the bread pan into the main unit, and plug the machine into the socket. (Make sure the start light is off.)

## 1 Select menu '11' (SD-2500: '10')



## 2 Press Start pad to start the machine



Time displayed indicating minutes until butter is added

- The start light will come on.

## 3 Adding additional butter when the beep sounds, then press Start pad again

Complete placing the additional cubed butter while 'Start' is flashing.

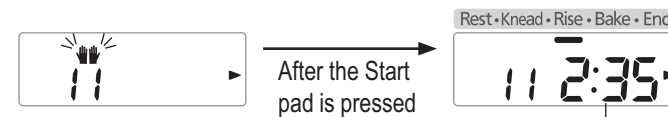

Display indicates remaining time until completion of the program

## 4 Press Stop pad and remove bread

when machine beeps 8 times and the bar at 'End' flashes

- The flashing start light will go off.

Yeast	1¼ tsp
Strong White Flour	400 g (14 oz)
Sugar	4 tbsp
Salt	1 tsp
Skimmed milk	2 tbsp
Butter (Cut into 2 cm cubes and keep in fridge)	50 g (2 oz)
Water	180 mL
Egg, medium (beaten)	2 (100 g)
Butter for adding later (Cut into 1–2 cm cubes and keep in fridge)	70 g (3 oz)

### [Simple way to bake brioche] Add butter with other ingredients at the beginning.

- Cut the butter into 2 cm cubes and place them into the bread pan at the same time as the other ingredients.
  - Follow the steps shown on the left. However, when the machine beeps on step 3 to add extra butter, please leave as it is.
  - Time required for completion is 3 hrs 30 minutes.
- \*When butter is added at the beginning, flavour, texture and rising of bread are a little different from the time bread is baked with extra butter added in later.
- A 'Rest' process will begin immediately after starting, followed by 'Knead' and 'Rise'.

- When adding extra ingredients such as raisins, add them with the butter. (Use max. 150 g for ingredients)
- Even without pressing the Start pad, kneading will continue after 5 min. It does not continue kneading immediately, even if the Start pad is pressed after adding butter or ingredients.
- Do not add butter after display shows remaining time. (P. 46)



# Making Dough

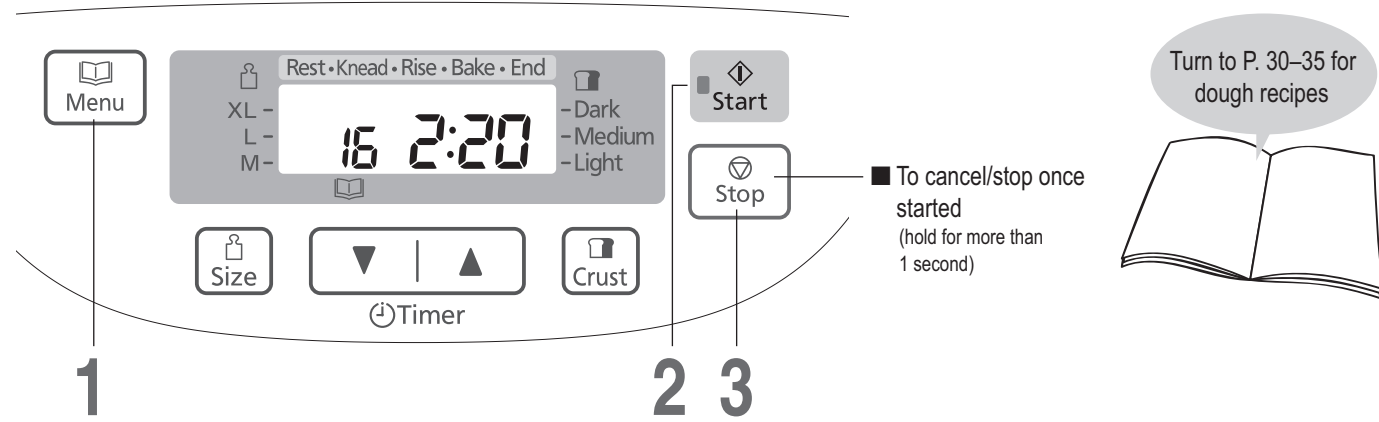

- Preparation (P. 12)
- Put the kneading blade into the bread pan.
  - Place the ingredients in the bread pan in the order listed in the recipe.
  - Set the bread pan into the main unit, and plug the machine into the socket. (Make sure the start light is off.)

## 1 Select a dough menu

[The display shows when menu '16' (SD-2500: '15') is selected.]



- Timer is not available on Dough menus [except menu 22 (SD-2500: 20)].
- If you would like to add extra ingredients to your dough, see P. 14.

## 2 Press Start pad to start the machine

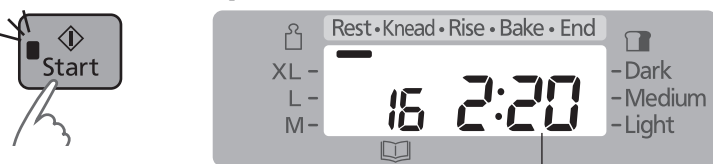

Time until the selected program is complete

- The start light will come on.

## 3 Press Stop pad and remove dough

- when machine beeps 8 times and the bar at 'End' flashes
- The flashing start light will go off.

- For menus other than 22, 26 and 27 (SD-2500: 20, 24 and 25), a 'Rest' process will begin immediately after starting, followed by 'Knead' and 'Rise'.

- Shape the finished dough and allow it to prove until doubled in size. Then bake in the oven according to recipe.

# Making Brioche Dough

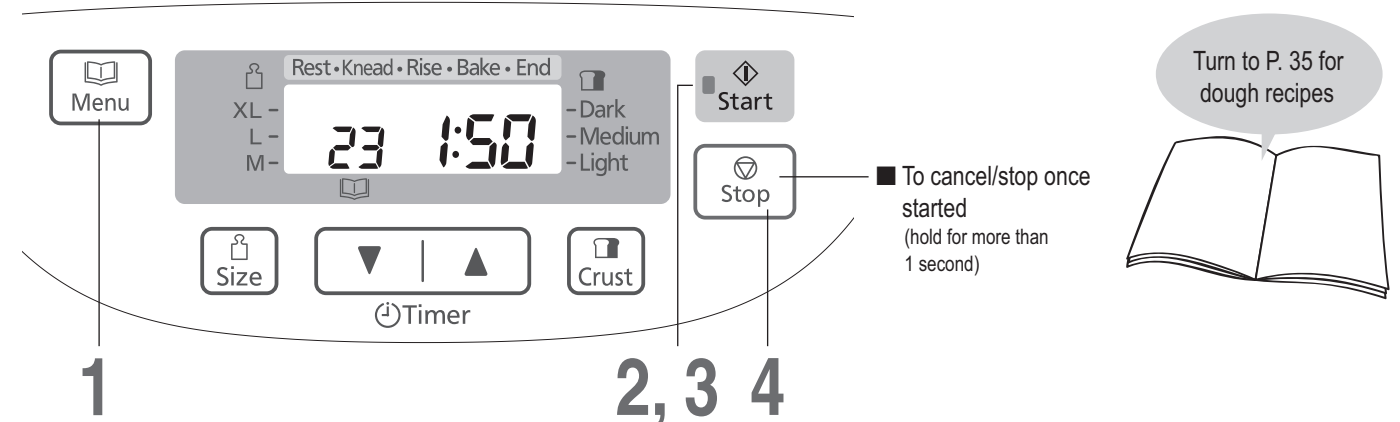

- Preparation (P. 12)
- Cut the butter for adding later into 1–2 cm cubes and keep them in fridge.
  - Put the kneading blade into the bread pan.
  - Place the ingredients in the bread pan in the order listed in the recipe.
  - Set the bread pan into the main unit, and plug the machine into the socket. (Make sure the start light is off.)

## 1 Select menu '23' (SD-2500: '21')

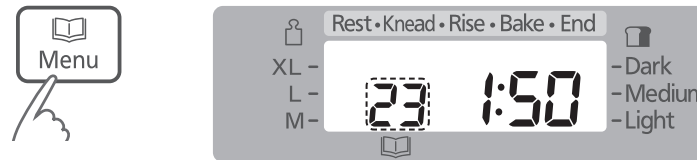

## 2 Press Start pad to start the machine

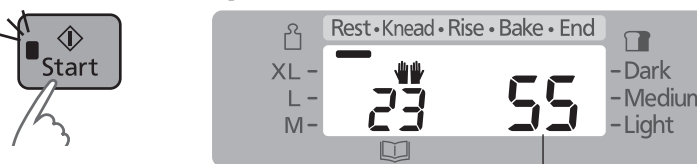

Time displayed indicating minutes until butter is added

- The start light will come on.

## 3 Adding additional butter when the beep sounds, then press Start pad again

Complete placing the additional cubed butter while '23' is flashing.

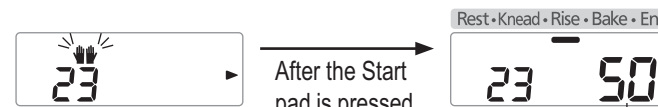

Display indicates remaining time until completion of the program

## 4 Press Stop pad and remove dough

when machine beeps 8 times and the bar at 'End' flashes

- The flashing start light will go off.

### [Simple way to make brioche] Add butter with other ingredients at the beginning.

- Cut the butter into 2 cm cubes and place them into the bread pan at the same time as the other ingredients.
- Follow the steps shown on the left. However, when the machine beeps on step 3 to add extra butter, please leave as it is.
- Time required for completion is 1 hr 50 minutes.
- \*When butter is added at the beginning, flavour, texture and rising of bread are a little different from the time bread is baked with extra butter added in later.
- A 'Rest' process will begin immediately after starting, followed by 'Knead' and 'Rise'.

- When adding extra ingredients such as raisins, add them with the butter. (Use max. 150 g for ingredients)
- Even without pressing the Start pad, kneading will continue after 5 min. It does not continue kneading immediately, even if the Start pad is pressed after adding butter or ingredients.
- Do not add butter after display shows remaining time. (P. 46)

- Shape the finished dough and allow it to prove until doubled in size. Then bake in the oven according to recipe.

# Baking Cakes

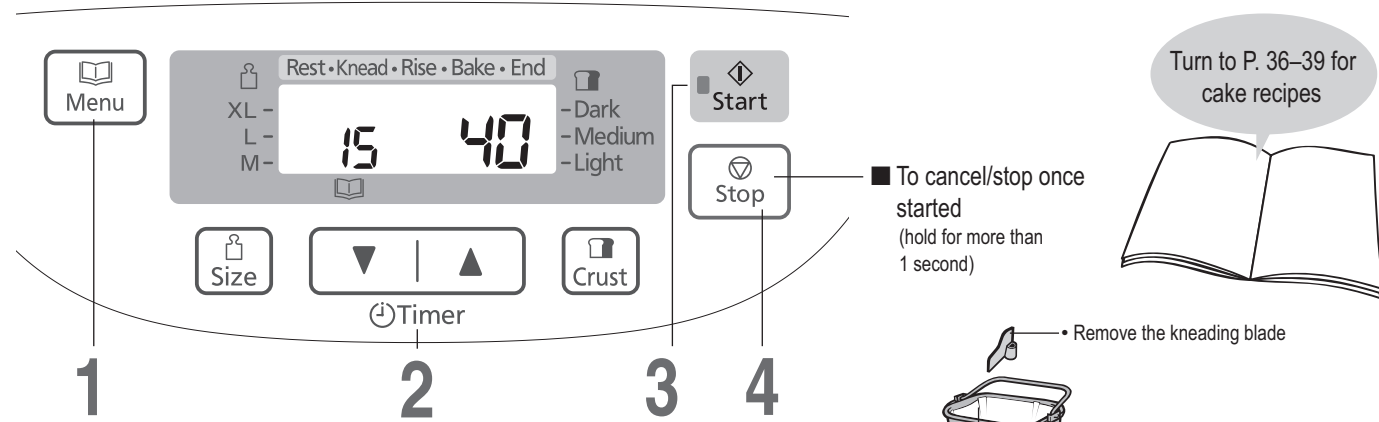

- Preparation
- ① Prepare the ingredients according to the recipe.
  - ② Line the bread pan with parchment paper or loaf tin liners and pour in the mixed ingredients.
  - ③ Set the bread pan into the main unit, and plug the machine into the socket. (Make sure the start light is off.)

## 1 Select menu '15' (SD-2500: '14')

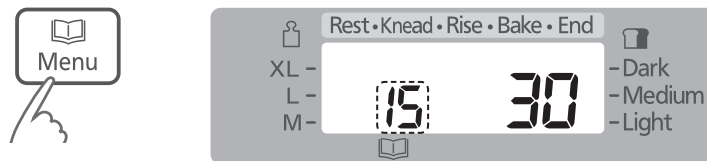

## 2 Press Timer pad to set the baking time



## 3 Press Start pad to start the machine



Time until the selected program is complete

- The start light will come on.

## 4 Press Stop pad when the machine beeps and the bar at 'End' flashes, check that baking is complete, and remove the pan

- The flashing start light will go off.
- If baking is not complete → Repeat steps 1-3 (Additional cooking time can be made up to twice. Each time should be within 50 minutes. The timer will start again from 1 minute when the unit is hot. Increase the time by pressing the timer pad as required.)



Line with parchment paper (Cake or tea bread will burn if it directly touches the bread pan.)

- Timer is not available on menu 15 (SD-2500: 14). (The Timer pad only sets the duration of the baking time.)

Take care!  
It's hot!

- To check whether baking is complete, insert a skewer into the centre of the cake or tea bread – it is ready if there is no mixture stuck to the skewer when you remove it.

# Making Jam

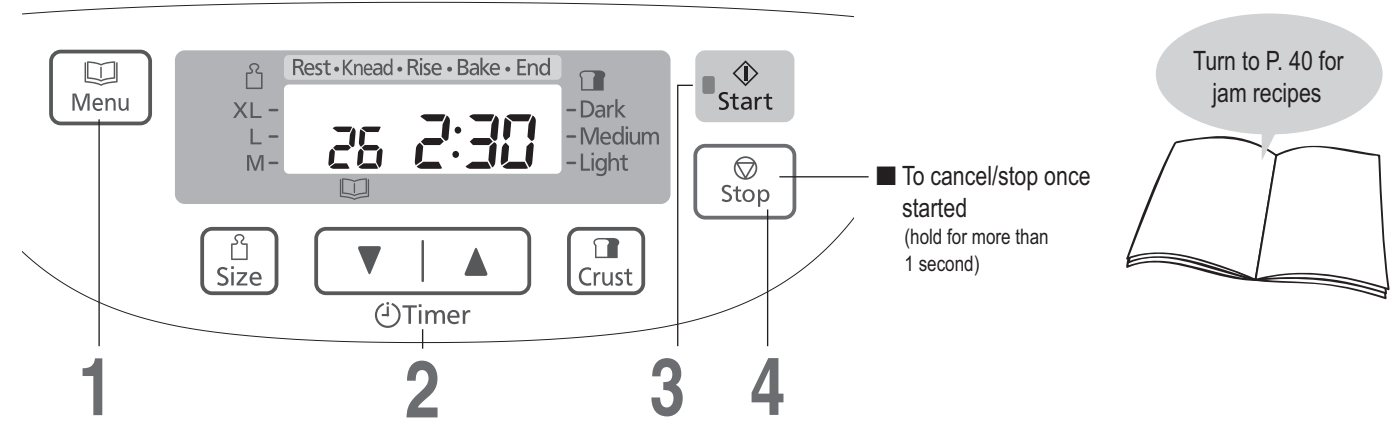

- Preparation
- ① Prepare the ingredients according to the recipe.
  - ② Put the kneading blade into the bread pan.
  - ③ Place the ingredients into the bread pan in the following order: half of the fruits → half of the sugar → remainder of fruits → remainder of sugar.
  - ④ Set the bread pan into the main unit, and plug the machine into the socket. (Make sure the start light is off.)

## 1 Select menu '26' (SD-2500: '24')



## 2 Press Timer pad to set the cooking time



## 3 Press Start pad to start the machine



Time until the selected program is complete

- The start light will come on.

## 4 Press Stop pad and remove jam

- when machine beeps 8 times and the bar at 'End' flashes
- The flashing start light will go off.
- If the cooking is not complete → Repeat steps 1-3 (Additional cooking time can be made up to twice. Each time should be within 10-40 minutes. The timer will start again from 1 minute when the unit is hot. Increase the time by pressing the timer pad as required.)

- Timer is not available on menu 26 (SD-2500: 24). (The Timer pad only sets the duration of the cooking time.)
- It is necessary to have an adequate amount of sugar, acid, and pectin to make firm set jam.
- Fruits with a high level of pectin set easily. Fruits with less pectin do not set well.
- Use freshly ripened fruits. Over or under ripe fruits do not set firmly.
- The recipes in this book make soft set jams. This is due to lower levels of sugar.
- Follow the recipe for the quantity for each ingredient.
  - Do not increase or decrease the quantities of fruits. It may cause the jam to boil over or scorch.
  - Do not increase the quantity of sugar more than half quantities of fruits. It may cause the jam to boil over or scorch. When decrease the quantity of sugar, jam does not set firm.
  - \*When the acidity of the fruit is strong, you can decrease quantity of the lemon juice but if it is decreased too much, jam does not set firm.
- When the cooking time is short, fruit bits can remain partially and the jam may become watery.
  - The jam will continue to set as it cools. Be careful not to over cook.

- Put the finished jam into the container as soon as possible. Please take care of the burn when you take out jam.
- Jam can burn if it is left in the bread pan.
- Store the jam in a cool, dark place. Due to the lower levels of sugar the shelf life is not as long as shop bought varieties. Once open, refrigerate and consume shortly after opening.

# Making Compote

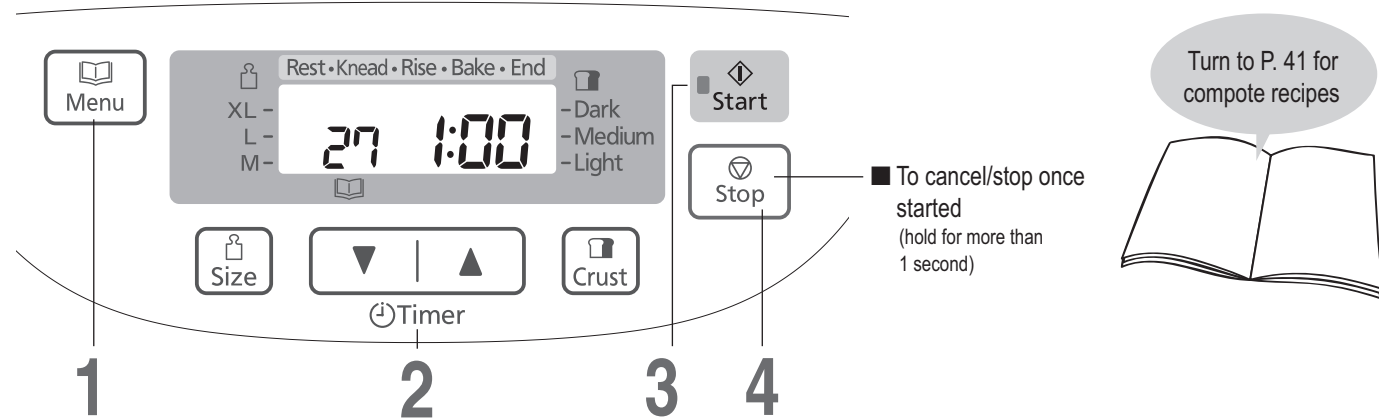

- Preparation
- ① Prepare the ingredients according to the recipe. (Remove the kneading blade.)
  - ② Place the ingredients into the bread pan in the following order: fruits → sugar → liquid.
  - ③ Set the bread pan into the main unit, and plug the machine into the socket. (Make sure the start light is off.)

## 1 Select menu '27' (SD-2500: '25')

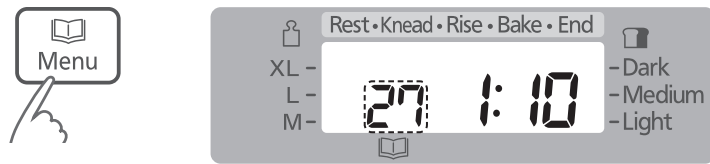

- Timer is not available on menu 27 (SD-2500: 25). (The Timer pad only sets the duration of the cooking time.)
- Follow the recipe for the quantities for each ingredient.
  - Do not increase or decrease the quantities of fruits. It may cause the compote to boil over or scorch.

## 2 Press Timer pad to set the cooking time



## 3 Press Start pad to start the machine



Time until the selected program is complete

- The start light will come on.

## 4 Press Stop pad and remove compote

when machine beeps 8 times and the bar at 'End' flashes

- The flashing start light will go off.
- If the cooking is not complete → Repeat steps 1–3 (Additional cooking time can be made up to twice. Each time should be within 10–40 minutes. The timer will start again from 1 minute when the unit is hot. Increase the time by pressing the timer pad as required.)

# Recipe Contents

## Bread Recipes

<b>Basic</b> [01 Basic] [02 Basic Rapid] [03 Basic Raisin]	White Loaf ..... 22 Rapid White Loaf ..... 22 Spicy Fruit Loaf ..... 22 Cider Apple Bread ..... 22 Apricot and Almond Loaf ..... 22 Milk Loaf ..... 22	Wheat Germ Loaf ..... 22 Oat and Bran Loaf ..... 22 Pizza Loaf ..... 22 5 Seeded Bread Loaf ..... 22 Brown Loaf ..... 23 Rapid Brown Loaf ..... 23	Malted Fruit Loaf ..... 23 Curry and Mango Loaf ..... 23 Cheese and Bacon Loaf ..... 23 Fresh Yeast White Loaf ..... 23
<b>Whole wheat</b> [04 Whole wheat] [05 Whole wheat Rapid] [06 Whole wheat Raisin]	Wholemeal Loaf 100% ..... 23 Wholemeal Loaf 70% ..... 23 Wholemeal Loaf 50% ..... 23 Rapid Wholemeal Loaf 100% ..... 23 Rapid Wholemeal Loaf 70% ..... 24 Rapid Wholemeal Loaf 50% ..... 24	Olive Loaf ..... 24 Fresh Yeast Wholemeal Loaf 100% ..... 24 Honey and Sunflower Loaf ..... 24 Pesto and Pine Nut Loaf ..... 24 Maple and Pecan Nut Loaf ..... 24	Spicy Fruit Loaf ..... 24 Seeded Wholemeal Loaf ..... 24 Onion Loaf ..... 25 Granary® Loaf ..... 25 Malted Brown Loaf ..... 25 Seeded Soya Loaf ..... 25
<b>Rye</b> [07 Rye] (SD-2501 only)	Rye 100% ..... 25 Rye and White ..... 25	Rye and Wholemeal ..... 25 Rye and Stout ..... 25	Seeded Rye ..... 25
<b>French</b> [08 French] (SD-2501) [07 French] (SD-2500)	French ..... 26 Rustic French ..... 26		
<b>Italian</b> [09 Italian] (SD-2501) [08 Italian] (SD-2500)	Easy Ciabatta ..... 26 Green Pesto, Onion and Garlic ..... 26	Sundried Tomato and Parmesan ..... 26 Mushroom and Pancetta ..... 26	Oregano and Olive ..... 26 Three Cheeses ..... 26 Tomato Focaccia ..... 26
<b>Sandwich</b> [10 Sandwich] (SD-2501) [09 Sandwich] (SD-2500)	White Sandwich ..... 26 Brown Sandwich ..... 26	Wholemeal Sandwich ..... 26 Granary® Sandwich ..... 26	
<b>Brioche</b> [11 Brioche] (SD-2501) [10 Brioche] (SD-2500)	Basic Brioche ..... 27 Pannettone ..... 27		
<b>Speciality</b> [13 Speciality] [14 Speciality Rasin] (SD-2501) [12 Speciality] [13 Speciality Rasin] (SD-2500)	Spelt White Bread ..... 27 Whole Spelt Bread ..... 27 Rye and Spelt ..... 27	Fruity Spelt ..... 27 Rice and Spelt with Pine Nut and Fried Onion ..... 27	Lemon and Poppy Seed Spelt ..... 27

## Gluten Free Recipes

[01 Basic] [12 Gluten Free] (SD-2501) [11 Gluten Free] (SD-2500)	<b>Gluten Free Bread</b> Glutafin Gluten Free Bread Mix ..... 29 Glutafin Gluten Free Fibre Bread Mix ..... 29 Juvela Bread Mixes ..... 29	<b>Gluten and Wheat Free</b> Glutafin Gluten Free/Wheat Free ..... 29 Gluten and Wheat Free Bread ..... 29 Doves Farm Gluten Free ..... 29	Juvela Bread Mixes ..... 29 Sainsbury's Free from Gluten and Wheat Free Bread Mix with Added Fibre ..... 29
--	---	---	--

## Dough Recipes

[16 Basic] [17 Basic Raisin] [18 Whole wheat] [19 Whole wheat Raisin] [20 Rye] [21 French] [22 Pizza] [23 Brioche] [24 Speciality] (SD-2501) [15 Basic] [16 Basic Raisin] [17 Whole wheat] [18 Whole wheat Raisin] [19 French] [20 Pizza] [21 Brioche] [22 Speciality] (SD-2500)	White Dough ..... 30 Brown Dough ..... 30 Wholemeal Dough 100% ..... 30 Wholemeal Dough 70% ..... 30 Wholemeal Dough 50% ..... 30 Granary® Dough ..... 31 Rye Dough 100% ..... 31 French Sticks ..... 31 Ciabatta ..... 31	Viennese Rolls ..... 31 Rye and White Rolls ..... 32 Wholemeal Walnut Rolls 70% ..... 32 Chelsea Buns ..... 32 Hot Cross Buns ..... 32 Croissants ..... 33 Soft Rolls/Baps ..... 33 Sweet Rolls/Buns Suitable for Devonshire Splits ..... 33	Dough for Tear & Share Bread ..... 34 Olive Tear & Share Bread ..... 34 Pepperoni Tear & Share Bread ..... 34 Picnic Tear & Share Bread ..... 34 Spelt Table Roll ..... 34 Brioche Dough (Chocolate Chip Brioche Roll) ..... 35 Focaccia ..... 35 Pizza ..... 35
---	--	---	---

## Cake Recipes

[15 Bake only] (SD-2501) [14 Bake only] (SD-2500)	Apple and Ginger Cake ..... 36 Banana and Walnut Loaf ..... 36 Boozy Cake ..... 37 Fruit Tea Bread ..... 37	Gingerbread ..... 37 Hazelnut and Honey Loaf ..... 38 Coffee & Pecan Nut Cake ..... 38 Cherry & Marzipan Cake ..... 38	Soda Bread ..... 39 Wholemeal Soda Bread ..... 39 Yeast and Dairy Free Spelt Loaf ..... 39 Cornbread ..... 39
--	--	---	--

## Jam Recipes

[26 Jam] (SD-2501) [24 Jam] (SD-2500)	Strawberry Jam ..... 40 Blueberry Jam ..... 40 Apple and Blackberry jam ..... 40	Peach Melba ..... 40 Plum Jam ..... 40 Frozen Berry Jam ..... 40	Redcurrant and Chilli Jam ..... 40 Apricot Jam ..... 40
--	--	--	--

## Compote Recipes

[27 Compote] (SD-2501) [25 Compote] (SD-2500)	Spiced Apple Compote ..... 41 Red fruits Compote ..... 41	Rhubarb and Ginger Compote ..... 41 Mixed Berry Compote ..... 41	Apple sauce ..... 41 Peach in Vanilla Syrup ..... 41
--	--	---	---



# Bread Recipes

**[04 Whole wheat]**  
**[05 Whole wheat]**  
**Rapid]**  
**[06 Whole wheat]**  
**Raisin]**  
 (wholemeal flour)

: Timer can be used for recipes with this symbol (5–13 hours)

## Rapid Wholemeal Loaf 70%

Menu '05' (3hr)

	M	L	XL
Yeast	1 tsp	1¼ tsp	1½ tsp
Strong Wholemeal Flour	300 g (11 oz)	350 g (12 oz)	420 g (15 oz)
Strong White Flour	100 g (4 oz)	150 g (5 oz)	180 g (6 oz)
Sugar	1 tsp	1½ tsp	2 tsp
Butter	15 g (½ oz)	25 g (1 oz)	25 g (1 oz)
Salt	1 tsp	1¼ tsp	1½ tsp
Water	300 mL	370 mL	430 mL

## Rapid Wholemeal Loaf 50%

Menu '05' (3hr)

	M	L	XL
Yeast	1 tsp	1¼ tsp	1½ tsp
Strong Wholemeal Flour	200 g (7 oz)	250 g (9 oz)	300 g (11 oz)
Strong White Flour	200 g (7 oz)	250 g (9 oz)	300 g (11 oz)
Sugar	1 tsp	1½ tsp	2 tsp
Butter	15 g (½ oz)	25 g (1 oz)	25 g (1 oz)
Salt	1 tsp	1¼ tsp	1½ tsp
Water	300 mL	370 mL	430 mL

## Olive Loaf

Menu '06' (5hr) (Timer can be used on SD-2501)

	M
Yeast	¾ tsp
Strong Wholemeal Flour	200 g (7 oz)
Strong White Flour	200 g (7 oz)
Sugar	1 tsp
Oil	3 tbsp
Salt	1 tsp
Oregano, dried	1 tbsp
Water	270 mL
*Whole Black Olives, pitted	75 g (3 oz)

## Fresh Yeast Wholemeal Loaf 100%

Menu '04' (5hr)

	L
Fresh Yeast	8 g (½ oz)
Strong Wholemeal Flour	500 g (1 lb 2 oz)
Sugar	1½ tsp
Oil	2 tbsp
Salt	1¼ tsp
Water	350 mL

## Honey and Sunflower Loaf

Menu '06' (5hr) (Timer can be used on SD-2501)

	L
Yeast	1 tsp
Strong Wholemeal Flour	250 g (9 oz)
Strong White Flour	250 g (9 oz)
Honey	2 tbsp
Butter	25 g (1 oz)
Salt	1¼ tsp
Water	340 mL
*Sunflower Seeds	4 tbsp

## Pesto and Pine Nut Loaf

Menu '06' (5hr) (Timer can be used on SD-2501)

	M	L	XL
Yeast	¾ tsp	1 tsp	1¼ tsp
Strong Wholemeal Flour	200 g (7 oz)	250 g (9 oz)	300 g (11 oz)
Strong White Flour	200 g (7 oz)	250 g (9 oz)	300 g (11 oz)
Sugar	1 tsp	1½ tsp	2 tsp
Salt	1 tsp	1¼ tsp	1½ tsp
Pesto	2 tbsp	3 tbsp	4 tbsp
Water	290 mL	360 mL	420 mL
*Pine Nuts	75 g (3 oz)	100 g (4 oz)	125 g (5 oz)

## Maple and Pecan Nut Loaf

Menu '06' (5hr) (Timer can be used on SD-2501)

	L
Yeast	¾ tsp
Strong Wholemeal Flour	200 g (7 oz)
Strong White Flour	200 g (7 oz)
Butter	15 g (½ oz)
Salt	1 tsp
Maple Syrup	3 tbsp
Water	280 mL
*Pecan Nuts, chopped	75 g (3 oz)

## Spicy Fruit Loaf

Menu '06' (5hr)

	M
Yeast	1 tsp
Strong Wholemeal Flour	400 g (14 oz)
Sugar	2 tsp
Butter	75 g (3 oz)
Salt	1 tsp
Cinnamon	2 tsp
Mixed Spice	1 tsp
Eggs, medium	2
Water	110 mL
Milk	110 mL
*Mixed Dried Fruit	150 g (5 oz)

## Seeded Wholemeal Loaf

Menu '06' (5hr) (Timer can be used on SD-2501)

	M	L	XL
Yeast	¾ tsp	1 tsp	1¼ tsp
Strong Wholemeal Flour	400 g (14 oz)	475 g (1 lb 1 oz)	550 g (1 lb 4 oz)
Sugar	1 tsp	1½ tsp	2 tsp
Butter	15 g (½ oz)	25 g (1 oz)	25 g (1 oz)
Salt	1 tsp	1¼ tsp	1½ tsp
Sesame Seeds	1 tbsp	1½ tbsp	2 tbsp
Poppy Seeds	1 tbsp	1½ tbsp	2 tbsp
Water	300 mL	350 mL	390 mL
*Linseeds	1 tbsp	1½ tbsp	2 tbsp
*Pumpkin Seeds	1 tbsp	1½ tbsp	2 tbsp
*Sunflower Seeds	1 tbsp	1½ tbsp	2 tbsp

• For addition of ingredients with\*, see the instructions on P.14.

## Onion Loaf

Menu '04' (5hr)

	M
Yeast	¾ tsp
Strong Wholemeal Flour	300 g (11 oz)
Strong White Flour	100 g (4 oz)
Sugar	1 tsp
Oil	1 tbsp
Salt	1 tsp
Onion, chopped and softened with 1 tsp oil	50 g (2 oz)
Garlic Puree	1 tsp
Creamed Horseradish	2 tsp
Water	270 mL

## Granary® Loaf

Menu '04' (5hr)

	M	L	XL
Yeast	¾ tsp	1 tsp	1¼ tsp
Strong Granary® Flour	400 g (14 oz)	500 g (1 lb 2 oz)	600 g (1 lb 5 oz)
Sugar	1 tsp	1½ tsp	2 tsp
Butter	15 g (½ oz)	25 g (1 oz)	25 g (1 oz)
Salt	1 tsp	1¼ tsp	1½ tsp
Water	280 mL	340 mL	400 mL

## Rye 100%

Menu '07' (3hr 30min)

Yeast	2½ tsp
Rye Flour	500 g (1 lb 2 oz)
Sugar	2 tsp
Oil	2 tbsp
Salt	2 tsp
Water	440 mL

## Rye and White

Menu '07' (3hr 30min)

Yeast	2 tsp
Rye Flour	250 g (9 oz)
Strong White Flour	250 g (9 oz)
Sugar	2 tsp
Oil	2 tbsp
Salt	2 tsp
Water	360 mL

## Rye and Wholemeal

Menu '07' (3hr 30min)

Yeast	2 tsp
Rye Flour	250 g (9 oz)
Strong Wholemeal Flour	250 g (9 oz)
Sugar	2 tsp
Oil	2 tbsp
Salt	2 tsp
Water	380 mL

## [07 Rye] (SD-2501 only) (rye flour)

- Remember to use the rye kneading blade (rye bread) for all these recipes.
- The Raisin nut dispenser does not operate on the Rye program.
- Put any additional ingredients directly into the bread pan at the start.
- As a result of the consistency some flour may remain on the sides of the loaf, but this is normal.
- Due to their consistency, the kneading blade will often become embedded in Rye Bread loaves. Wait for the loaf to cool (to avoid burning your hands), before removing the blade by pressing on the base of the loaf and manipulating it out gently to avoid damaging the loaf.

: Timer can be used for recipes with this symbol (3hr 30min–13 hours)

## Malted Brown Loaf

Menu '04' (5hr)

	M	L	XL
Yeast	¾ tsp	1 tsp	1¼ tsp
Strong Granary® Flour	250 g (9 oz)	300 g (11 oz)	350 g (12 oz)
Strong White Flour	150 g (5 oz)	200 g (7 oz)	250 g (9 oz)
Sugar	1 tsp	1½ tsp	2 tsp
Butter	15 g (½ oz)	25 g (1 oz)	25 g (1 oz)
Salt	1 tsp	1¼ tsp	1½ tsp
Water	280 mL	350 mL	400 mL

## Seeded Soya Loaf

Menu '06' (5hr)

	M
Yeast	1 tsp
Strong White Flour	300 g (11 oz)
Soya Flour	100 g (4 oz)
Sugar	2 tsp
Butter	25 g (1 oz)
Salt	1 tsp
Poppy Seeds	3 tbsp
Sesame Seeds	2 tbsp
Water	240 mL
Soya Milk	120 mL
*Linseeds	50 g (2 oz)
*Sunflower Seeds	1 tbsp
*Pumpkin Seeds	1 tbsp

• This loaf is made with strong white flour but benefits from the 5 hour cycle.

## Rye and Stout

Menu '07' (3hr 30min)

Yeast	2½ tsp
Rye Flour	500 g (1 lb 2 oz)
Sugar	2 tsp
Oil	2 tbsp
Salt	2 tsp
Water	220 mL
Guinness®/Stout	220 mL

## Seeded Rye

Menu '07' (3hr 30min)

Yeast	2½ tsp
Rye Flour	500 g (1 lb 2 oz)
Sugar	2 tsp
Oil	2 tbsp
Salt	2 tsp
Poppy Seeds	2 tbsp
Linseeds	3 tbsp
Sunflower Seeds	3 tbsp
Water	430 mL

• For addition of ingredients with\*, see the instructions on P.14.



# Gluten Free Recipes

## [01 Basic]

[12 Gluten Free] (SD-2501)

[11 Gluten Free] (SD-2500)  
(gluten free bread mix / wheat free bread mix)

: Timer cannot be used

- The raisin nut dispenser does not operate on the Gluten Free program.
- Put any additional ingredients directly into the bread pan at the start.
- You can bake gluten free cakes following our recipes on P. 36–39 by substituting gluten free plain flour for standard plain flour. If self-raising flour is required also add 1 tsp of gluten free baking powder.
- You can purchase gluten free bread mix at:
  - Pharmacies
  - Health food shops
  - Major supermarkets

### Note

- Making gluten free bread is very different from the normal way of producing bread in the Bread Maker. Please read through the guidelines on the right.
- Please consult flour manufacturers for detailed information.
- As a result of consistency some flour may remain on the sides of the loaf, but this is normal.
- Wait for the loaf to cool before slicing it for the better performance.

## Before making gluten free bread

### ■ Consult your doctor and follow the guidelines below!

If you make gluten free bread as part of dietary therapy, it is important that you avoid cross-contamination with flour that does contain gluten.

Please take particular care when washing the bread pan and the kneading blade, etc.

### ■ It is made differently to other types of bread!

The order of putting in ingredients is different

Please put in the ingredients in the following order so that the gluten free bread mix is well mixed. (The wrong order may result in poor rising)

→ Water, salt, fat → gluten free bread mix

The outcome differs depending on the type of flour

The recipes on the right have been developed with particular types of bread mix, and so the final outcome may differ depending on the actual bread mix used. (There may be greater variation with wheat free bread mixes.)

→ You can order extra bread pans and kneading blades at the following:

• Customer Care Centre: 0844 8443868

• Direct Online:  
<http://www.panasonic.co.uk>

If kneading blade becomes embedded in bread

Due to their consistency, the kneading blade will often become embedded in Gluten and Wheat Free Bread loaves. Wait for the loaf to cool (to avoid burning your hands), before removing the blade by pressing on the base of the loaf and manipulating it out gently to avoid damaging the loaf.

Consume within two days

Store your finished bread in a cool, dry place, and consume within two days. If you cannot finish it all in time, cut it into slices, place in a freezer bag and into the freezer.

## ■ Flavoured Gluten Free Loaves

Use one quantity of chosen mix and add the following ingredients to your bread pan to produce the loaf of your choice.

- Select Medium crust unless otherwise stated.

### Spicy Fruit Loaf

- 100 g (4 oz) mixed fruit
- 2 tsp cinnamon

### Date & Raisin Loaf

- juice of 2 oranges (made up to the quantity of water required), placed in the bread pan before gluten free mix
- 2 tsp mixed spice
- 150 g (5 oz) chopped dates
- 100 g (4 oz) raisins
- rind of 2 oranges

### Maple & Pecan Loaf

- 2 tbsp Maple syrup
- 50 g (2 oz) Pecans

### Five Seeds Loaf (Dark Crust)

- 1 tbsp linseeds
- 2 tbsp sesame seeds
- 1 tbsp pumpkin seeds
- 1 tbsp poppy seeds
- 1 tbsp sunflower seeds

### Sundried Tomato & Parmesan Loaf (Dark Crust)

- 50 g (2 oz) parmesan cheese grated
- 50 g (2 oz) sundried tomatoes in oil, drained and chopped

## Gluten Free Bread

### Glutafin Gluten Free Bread Mix

Menu '12' (SD-2500: '11') - 'Dark' Crust (1hr 55min) 

Tepid Water	400 mL
Oil	2 tsp
Bread Mix	500 g (1 lb 2 oz)
Yeast	3 tsp

### Glutafin Gluten Free Fibre Bread Mix

Menu '12' (SD-2500: '11') - 'Dark' Crust (1hr 55min) 

Hot Water from the Kettle	200 mL
Cold Tap Water	200 mL
Oil	1½ tbsp
Bread Mix	500 g (1 lb 2 oz)
Yeast	3 tsp

### Juvela Bread Mixes

Menu '12' (SD-2500: '11') - 'Dark' Crust (1hr 55min) 

	Gluten Free Mix	Fibre Mix
Water	400 mL	430 mL
Salt	½ tsp	½ tsp
Oil	1 tbsp	1 tbsp
Bread Mix	500 g (1 lb 2 oz)	500 g (1 lb 2 oz)
Yeast	2 tsp	2 tsp

## Gluten and Wheat Free

Wheat Free bread is quite different from gluten free bread as it does not contain wheat starch. Some wheat free mixes are better suited to longer cycles. Please check all ingredients listing for computability with your diet. Barley contains gluten.

### Glutafin Gluten Free/Wheat Free

Menu '12' (SD-2500: '11') - 'Large' Size - 'Dark' Crust (1hr 55min) 

	Bread Mix	Fibre Bread Mix
Tepid Water	450 mL	480 mL
Oil	1 tbsp	1 tbsp
Bread Mix	500 g (1 lb 2 oz)	500 g (1 lb 2 oz)
Yeast	3 tsp	3 tsp

### Gluten and Wheat Free Bread

Menu '01' - 'Medium' Crust (4hr) 

Warm Water + 1 Egg + 1 Egg White made up to	430 mL
Melted Butter	60 mL
Cider Vinegar	1 tsp
Brown Rice Flour	300 g (11 oz)
Potato Starch	100 g (4 oz)
Skimmed Milk Powder	50 g (2 oz)
Xanthum Gum	1 tbsp
Sugar	1 tbsp
Salt	1 tsp
Yeast	1 tsp

• The milk powder may be omitted.

### Doves Farm Gluten Free

Menu '12' (SD-2500: '11') - 'Dark' Crust (1hr 55min) 

	Brown Bread Flour	White Bread Flour
Water	330 mL	320 mL
Cider Vinegar	1 tsp	1 tsp
Vegetable Oil	4 tbsp	4 tbsp
Egg, medium	1	1
Medium Sized Egg, white	1	1
Flour	450 g (1 lb)	450 g (1 lb)
Sugar	1 tbsp	1 tbsp
Salt	1 tsp	1 tsp
Yeast	2 tsp	2 tsp

### Juvela Bread Mixes

Menu '12' (SD-2500: '11') - 'Dark' Crust (1hr 55min) 

	Harvest Mix Wheat Free
Water	420 mL
Salt	½ tsp
Oil	1 tbsp
Bread Mix	500 g (1 lb 2 oz)
Yeast	2 tsp

### Sainsbury's Free from Gluten and Wheat Free Bread Mix with Added Fibre

Menu '12' (SD-2500: '11') - 'Dark' Crust (1hr 55min) 

Water	440 mL
Vegetable Oil	2 tbsp
Bread Mix	500 g (1 lb 2 oz)
Yeast	2 tsp

# Dough Recipes



[16 Basic] [17 Basic Raisin] [18 Whole wheat] [19 Whole wheat Raisin] [20 Rye] [21 French] [22 Pizza] [23 Brioche] [24 Speciality] (SD-2501)

[15 Basic] [16 Basic Raisin] [17 Whole wheat] [18 Whole wheat Raisin] [19 French] [20 Pizza] [21 Brioche] [22 Speciality] (SD-2500)

The Dough setting mixes and gives the dough its first rising before you shape and bake it in your conventional oven.

⊗: Timer cannot be used (except pizza)

Prepare your ingredients according to the recipe and select the correct menu. When your dough is ready, shape it, allow it to rise, and then bake it yourself.

- The maximum load of the Bread Maker is 600 g (1 lb 5 oz). Dough recipes using 300 g (11 oz) of flour may be doubled.
- When the DOUGH program has completed its operation, you may find that the prepared dough is easier to shape if it is tipped onto a lightly floured board before handling.

## Example – making plain bread rolls

### ① Shaping

Dough can be shaped into round rolls, plaits, knots, French sticks, large or small cobs or put in a traditional loaf tin.

#### ● Rolls

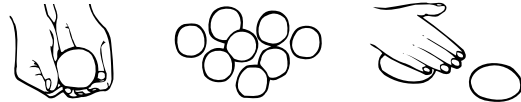

#### ● Knot



#### ● Hedgehogs

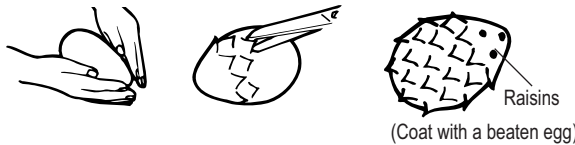

### ② Proving

Most recipes require the dough to be left to prove i.e. to be left to rise after shaping, before the final baking. Generally the dough should be left to prove in a warm place (at approximately 40°C/105°F) until the dough has doubled in size.

- Approximate proving time-Rolls 25 mins, Whole breads e.g. Panettone etc 50 mins
- To prevent a hard dry skin forming, cover the dough with a large polythene bag or cover with lightly oiled cling film.

### ③ Glazing/Baking

Brush with milk, salted water, beaten egg or oil. Sprinkle with poppy seeds, sesame seeds. Bake following recipe guidelines.

## Rolls

- Select one of the following recipes and follow the method below.

### 1 Shape dough.



### 2 Place onto a greased baking tray and allow to prove until doubled in size.

### 3 Brush with beaten egg.

### 4 Bake in a preheated oven at 220°C/425°F/Gas Mark 7 for 10–15 mins or until golden brown.

## White Dough

Menu '16' (SD-2500: '15') (2hr 20min) ⊗

Yeast	1¼ tsp
Strong White Flour	600 g (1 lb 5 oz)
Sugar	2 tsp
Oil	2 tbsp
Salt	1½ tsp
Water	350 mL

## Brown Dough

Menu '16' (SD-2500: '15') (2hr 20min) ⊗

Yeast	1¼ tsp
Strong Brown Flour	600 g (1 lb 5 oz)
Sugar	2 tsp
Oil	2 tbsp
Salt	1½ tsp
Water	350 mL

## Wholemeal Dough 100%

Menu '18' (SD-2500: '17') (3hr 15min) ⊗

Yeast	1½ tsp
Strong Wholemeal Flour	600 g (1 lb 5 oz)
Sugar	2 tsp
Oil	2 tbsp
Salt	1½ tsp
Water	380 mL

## Wholemeal Dough 70%

Menu '18' (SD-2500: '17') (3hr 15min) ⊗

Yeast	1½ tsp
Strong Wholemeal Flour	425 g (15 oz)
Strong White Flour	175 g (6 oz)
Sugar	2 tsp
Oil	2 tbsp
Salt	1½ tsp
Water	370 mL

## Wholemeal Dough 50%

Menu '18' (SD-2500: '17') (3hr 15min) ⊗

Yeast	1½ tsp
Strong Wholemeal Flour	300 g (11 oz)
Strong White Flour	300 g (11 oz)
Sugar	2 tsp
Oil	2 tbsp
Salt	1½ tsp
Water	370 mL

## Granary® Dough

Menu '18' (SD-2500: '17') (3hr 15min) ⊗

Yeast	1½ tsp
Strong Granary® Flour	600 g (1 lb 5 oz)
Sugar	2 tsp
Oil	2 tbsp
Salt	1½ tsp
Water	350 mL

## Rye Dough 100% (SD-2501 only)

Menu '20' (2hr) ⊗

Yeast	2 tsp
Rye Flour	500 g (1 lb 2 oz)
Sugar	2 tsp
Oil	3 tbsp
Salt	2 tsp
Water	360 mL

- Use kneading blade (rye bread).
- Prove for 15 mins.

## French Sticks

Menu '21' (SD-2500: '19') (3hr 35min) ⊗

Yeast	½ tsp
Strong White Flour	250 g (9 oz)
Butter	15 g (½ oz)
Salt	½ tsp
Water	150 mL

## Ciabatta

Stage 1 Culture : Menu '22' (SD-2500: '20') (45min) Ⓢ

Yeast	½ tsp
Strong White Flour	175 g (6 oz)
Water	200 mL

Stage 2 : Menu '16' (SD-2500: '15') (2hr 20min) ⊗

Yeast	¼ tsp
Strong White Flour	325 g (11½ oz)
Sugar	½ tsp
Olive Oil	2 tbsp
Salt	1½ tsp
Water	80 mL

### 1 Put all culture ingredients in the bread pan and select menu 22 (SD-2500: 20).

### 2 Turn off at the start pad after 15 mins. (12 hours later)

### 3 Add all ingredients listed in stage 2 and select menu 16 (SD-2500: 15) program 2 hrs 20 mins.

### 4 Divide dough into 2 and roll each half out to a rough oblong loaf shape about 2.5 cm (1") thick.

### 5 Place on a greased baking tray and sprinkle with flour. Allow to prove at 40°C/105°F until doubled in size (approx. 20 mins).

### 6 Bake in a preheated oven at 220°C/425°F/Gas Mark 7 for 20–25 mins or until golden brown.

- This dough can also be made as a loaf. Follow method for steps 1–3. Increase water on stage 2 from 80–110 mL and select menu 09 (SD-2500: 08).

## Viennese Rolls

Menu '16' (SD-2500: '15') (2hr 20min) ⊗

Yeast	¼ tsp
Strong White Flour	400 g (14 oz)
Sugar	50 g (2 oz)
Butter	100 g (4 oz)
Salt	½ tsp
Medium Sized Eggs, yolk	2
Egg, medium	1
Milk warmed	150 mL
Filling (jam or mincemeat)	½ jar
Glaze (milk)	45 mL (3 tbsp)

### 1 Divide dough into 20 rolls.

### 2 Roll out each piece of dough to a square shape approximately 10 cm x 10 cm (4" x 4") in size.

### 3 Place a teaspoon of filling in the centre of each piece of dough. Draw up the corners and edges to make a parcel. Repeat with all 20 rolls.

### 4 Place parcels in two 20 cm (8") greased cake tins, with the gathered side down. Glaze with milk and allow to prove at 40°C/105°F until doubled in size (approx. 20–30 mins).

### 5 Bake in a preheated oven at 190°C/375°F/Gas Mark 5 for 15–20 mins or until golden brown.

- Serve just warm as a breakfast or tea-time treat.



# Dough Recipes

## Rye and White Rolls (SD-2501 only)

Stage 1 Culture : Menu '22' (45min) ⌚

Yeast	1 tsp
Strong White Flour	75 g (3 oz)
Rye flour	150 g (5 oz)
Water	200 mL

Stage 2 : Menu '20' (2hr) ⌚

Yeast	1 tsp
Rye Flour	150 g (5 oz)
Strong White Flour	100 g (4 oz)
Sugar	2 tsp
Oil	3 tbsp
Salt	2 tsp
Water	60 mL

- Put all culture ingredients in the bread pan and select menu 22.
  - Use kneading blade (rye bread).
- Turn off at the start pad after 15 mins.
  - (12 hours later)
- Add all ingredients listed in stage 2 and select menu 20.
- Divide dough into 12–15 pieces and shape into rolls.
- Place on a greased baking tray and sprinkle with flour. Allow to prove at 40°C/105°F until doubled in size (approx. 20 mins).
- Glaze with oil and bake in a preheated oven at 220°C/425°F/ Gas Mark 7 for 10–15 mins or until golden brown.

• This dough can also be made as a loaf. Follow method for steps 1–3. Increase water on stage 2 from 80–110 mL and select menu 09.

## Wholemeal Walnut Rolls 70%

Menu '19' (SD-2500: '18') (3hr 15min) ⌚

Yeast	1 tsp
Strong Wholemeal Flour	350 g (12 oz)
Strong White Flour	100 g (4 oz)
Medium Oatmeal	50 g (2 oz)
Maple Syrup	2 tbsp
Oil	2 tbsp
Salt	1½ tsp
Water	320 mL
*Walnut	100 g (4 oz)

- Divide dough into 12 large rolls or 20 dinner rolls.
- Place on a greased baking trays and sprinkle with flour. Allow to prove at 40°C/105°F until doubled in size (approx. 20 mins).
- Bake in a preheated oven at 220°C/425°F/Gas Mark 7 for 12–15 mins or until golden brown.

## Chelsea Buns

Enriched Dough : Menu '16' (SD-2500: '15') (2hr 20min) ⌚

Yeast	½ tsp
Strong White Flour	250 g (9 oz)
Sugar	1 tsp
Butter	25 g (1 oz)
Milk Powder	1 tbsp
Salt	½ tsp
Egg, medium	1
Water	100 mL

### Additional Ingredients

Butter	15 g (½ oz)
Mixed Dried Fruit	100 g (4 oz)
Soft Brown Sugar	50 g (2 oz)
Mixed Spice	1 tsp

- Knead the dough lightly and roll out to an oblong 26 cm x 20 cm (10" x 8").
- Mix together the mixed dried fruit, soft brown sugar and mixed spice. Brush the dough with melted butter and spread the fruit mixture on top. Roll up from the long edge and cut into 8–10 slices. Arrange in a greased 23 cm (9") sandwich tin and allow to prove at 40°C/105°F until doubled in size (approx. 20 mins).
- Bake in a preheated oven at 220°C/425°F/Gas Mark 7 for 15 mins or until golden brown.
- Allow to cool. Drizzle with glaze icing.

## Hot Cross Buns

Menu '17' (SD-2500: '16') (2hr 20min) ⌚

Enriched Dough Ingredients (above)	One batch
Cinnamon	1 tsp
Mixed Spice	½ tsp
*Mixed Dried Fruit	100 g (4 oz)





- Divide mixture into eight balls. Place on a lightly greased baking tray and allow to prove at 40°C/105°F until doubled in size (approx. 20 mins). Make a paste with approx. 2 tbsp flour mixed with 2 tbsp water and pipe a cross over the buns, or top with thin slices of shortcrust pastry.
- Bake in a preheated oven at 220°C/425°F/Gas Mark 7 for 15–20 mins or until golden brown.
- While still HOT, brush with a sugar glaze — 40 g (1½ oz) sugar in 4 tbsp water, boiled until a syrup is reached — (approx. 5 mins).

• For addition of ingredients with\*, see the instructions on P.14.

## Croissants

Menu '16' (SD-2500: '15') (2hr 20min) ⌚

Yeast	½ tsp
Strong White Flour	300 g (11 oz)
Sugar	1 tsp
Butter	25 g (1 oz)
Salt	½ tsp
Egg, medium	1
Water	150 mL
Butter chilled to add when rolling	150 g (5 oz)

- Roll dough to 20 cm x 25 cm (8" x 10") rectangle.
 
- Divide butter into three portions. Dot one portion over the top two thirds of the dough.
- Fold the bottom one third up and the top one third down, sealing the edges with a rolling pin. Turn the dough so that the folded edge is on the side.
- Roll out to an oblong, dot the second portion of butter and continue as before. Repeat with the third portion.
 
- Cover and allow the dough to rest in the refrigerator for 30 mins.
- Repeat the rollings three more times, cover and chill for 30 mins.
- Roll out pastry and divide into four squares. Cut each square into two triangles. Reroll the each triangle long and thin.
 
- Loosely roll up each triangle towards the point, finishing with tip underneath. Curve into a crescent shape.
 
- Place on a greased baking tray. Allow to prove at 40°C/105°F until doubled in size (approx. 20 mins).
 
- Brush with beaten egg and bake in a preheated oven at 220°C/425°F/Gas Mark 7 for 15 mins or until crisp and well browned.

## Soft Rolls/Baps

Menu '16' (SD-2500: '15') (2hr 20min) ⌚

Yeast	1 tsp
Strong White Flour	450 g (1 lb)
Sugar	½ tsp
Butter	25 g (1 oz)
Salt	½ tsp
Egg, medium	1
Water	**250 mL

\*\* For a slightly denser roll try 125 mL water and 125 mL milk.

## Sweet Rolls/Buns Suitable for Devonshire Splits

Menu '16' (SD-2500: '15') (2hr 20min) ⌚

Yeast	1 tsp
Strong White Flour	450 g (1 lb)
Sugar	2 tbsp
Butter	75 g (3 oz)
Salt	½ tsp
Egg, medium	1
Milk	250 mL

- Choose one of the above recipes.
- Place the ingredients into the bread pan in the order listed above.
- Select menu 16 (SD-2500: 15).
- Divide dough into 8–10 pieces and shape into baps.
- Place on a greased baking tray and allow to prove at 40°C/105°F until doubled in size (approx. 20 mins).
- Dust with flour.
- Bake in a preheated oven at 220°C/425°F/Gas Mark 7 for 15 mins or until golden brown.
  - For devonshire splits, split bun and fill with cream and jam. Top with glaze icing.

# Dough Recipes

## Dough for Tear & Share Bread

Menu '16' (SD-2500: '15') (2hr 20min)

Yeast	1¼ tsp
Strong White Flour	550 g (1 lb 4 oz)
Sugar	2 tsp
Olive Oil	2 tbsp
Salt	1½ tsp
Water	310 mL

## Olive Tear & Share Bread

Dough for Tear & Share Bread (above)	One batch
Tapenade (green or black)	6 tbsp
Olives, chopped	25 g (1 oz)
Olive Oil	2 tbsp

- Roll dough out into a rectangular sheet 1½ cm (½") thick, approximately 24 cm x 46 cm (9" x 18").
- Spread the Tapenade over the dough, sprinkle the chopped olives and drizzle with 1 tbsp of the oil. Roll up from the short end like a swiss roll.
- Cut the dough into 4 cm (1½") slices with a sharp knife and place close together in a 20 cm (8") round greased cake or flan tin, cut sides up.
- Drizzle with the remaining tbsp of oil and allow to prove at 40°C/105°F until doubled in size (approx. 25 mins).
- Bake in a preheated oven at 220°C/425°F/Gas Mark 7 for 15–20 mins or until golden brown.

• Delicious served warm with tapas or pasta dishes.

## Pepperoni Tear & Share Bread

Dough for Tear & Share Bread (above)	One batch
Tomato Puree or Sun Dried Tom Puree	4 tbsp
Pepperoni, chopped	50 g (2 oz)
Mozarella Cheese, grated	100 g (4 oz)
Dried Oregano or Basil	1 tsp
Olive Oil	1 tbsp

- Roll dough out into a rectangular sheet 1½ cm (½") thick, approximately 24 cm x 46 cm (9" x 18").
- Spread the tomato puree over the dough and scatter the pepperoni and cheese. Roll up from the short end like a swiss roll.
- Cut the dough into 4 cm (1½") slices with a sharp knife and place close together in a 20 cm (8") round greased cake or flan tin, cut sides up.
- Drizzle with the olive oil and sprinkle with the dried herbs and allow to prove at 40°C/105°F until doubled in size (approx. 25 mins).
- Bake in a preheated oven at 220°C/425°F/Gas Mark 7 for 15–20 mins or until golden brown.

• Delicious served warm with pasta dishes. Use sundried tomatoes in place of pepperoni for vegetarians.

## Picnic Tear & Share Bread

Dough for Tear & Share Bread (on the left)	One batch
Grainy Mustard	2 tbsp
Cooked Ham, chopped	75 g (3 oz)
Strong Cheddar Cheese, grated	75 g (3 oz)

- Roll dough out into a rectangular sheet 1½ cm (½") thick, approximately 24 cm x 46 cm (9" x 18").
- Spread the mustard over the dough and scatter the ham and cheese—reserve a little of the cheese to sprinkle on top. Roll up from the short end like a swiss roll.
- Cut the dough into 4 cm (1½") slices with a sharp knife and place close together in a 20 cm (8") round greased cake or flan tin, cut sides up.
- Sprinkle with the remaining cheese and allow to prove at 40°C/105°F until doubled in size (approx. 25 mins).
- Bake in a preheated oven at 220°C/425°F/Gas Mark 7 for 15–20 mins or until golden brown.

• Delicious served warm with soup or with a Ploughmans lunch.

## Spelt Table Roll

; for 8 rolls

Menu '24' (SD-2500: '22') (2hr 45min)

Yeast	1¼ tsp
Spelt White Flour	500 g (1 lb 2 oz)
Sugar	1½ tsp
Salt	1½ tsp
Butter	10 g (½ oz)
Water*	310 mL

\*If in the hot room, use chilled water

- Divide dough into 8 rolls and rest them for 15 mins.
- Shape the dough into rolls.
- Place on a greased baking tray and allow to prove at 35°C/95°F until doubled in size.(approx.40 mins.)
- Make a cut on top of the dough and bake in oven at 220°C/425°F for 15-20 mins. (coupe)

## Brioche Dough (Chocolate Chip Brioche Roll)

; for 12 rolls

Menu '23' (SD-2500: '21') (1hr 50min)

Yeast	1½ tsp
Strong White Flour	400 g (14 oz)
Sugar	4 tbsp
Salt	1½ tsp
Butter (Cut into 2 cm cubes and keep in fridge)	70 g (3 oz)
Egg (beaten)	3 (150 g)
Milk	90 mL
Ram (dark)	15 mL (1 tbsp)
Additional Butter* (Cut into 1–2 cm cubes and keep in fridge)	50 g (2 oz)

### Optional Ingredients

Chocolate chips	120 g (4½ oz)
-----------------	---------------

• For addition of ingredients with\*, follow programming instructions on P. 17.

- Press the dough lightly to remove the gas.
- Shape it round and wrap it with plastic wrap. Then rest it in the refrigerator for 20 mins.
  - When you like to add chocolate chips, follow below instructions. (Optional)
    - Roll the dough to 25 cm x 30 cm (10"x12")
    - Sprinkle chocolate chips and fold the bottom one third up and the top one third down. Then fold it in half.
    - Rest the dough in the room temperature for 10 mins again. (Do not dry it.)
- Press the dough lightly to remove the gas again, and divide it into 12 rolls.
- Rest the dough in the room temperature for 10–15 mins. (Do not dry it out.)
- Shape the dough and place them on a greased baking tray and allow to prove at 35°C/95°F for 30–40 mins.
- Glaze and bake in oven at 180°C/356°F for 15–20 mins.

## Focaccia

Menu '22' (SD-2500: '20') (45min)

Yeast	½ tsp
Strong White Flour	300 g (11 oz)
Olive Oil	1 tbsp
Salt	1 tsp
Water	170 mL

- Roll and pat the dough into a 30 cm x 25 cm (12" x 10") rectangle on a greased baking tray.
- Make indentations over the whole dough using your fingertips.
- Add one of the following toppings:
  - 1 small red onion sliced and softened with 1 tsp olive oil and 1 tsp balsamic vinegar. (Do this in a bowl covered in cling film in the microwave for 1–2 min).
  - 2 tbsp chopped black or green olives.
  - 2 chopped cloves of garlic, sea salt and cracked black pepper corns.
  - 2 tbsp chopped sundried tomatoes.
- Allow to prove at 40°C/105°F until doubled in size (approx. 30 mins).
- Drizzle with olive oil and bake in a preheated oven at 190°C/375°F/Gas Mark 5 for 20–30 mins or until golden at the edges and cooked well in the centre.

• Serve warm with pasta dishes.

## Pizza

Menu '22' (SD-2500: '20') (45min)

Yeast	½ tsp
Strong White Flour	300 g (11 oz)
Olive Oil	1 tbsp
Salt	1 tsp
Water	170 mL

- Press out dough using the heel of your hand to a 25 cm (10") circle or two 25 cm (10") circles for thin and crispy base on a greased baking tray.
- Allow to prove at 40°C/105°F until doubled in size (approx. 20 mins).
- Add topping of your choice and bake in a preheated oven at 220°C/425°F/Gas Mark 7 for 15–20 mins, depending on amount of topping.

• To freeze pizza bases follow method to step 2 and bake without toppings for 5 mins. Allow to cool, freeze. To use remove from freezer immediately add topping (not too much) and bake as above step 3.

# Cake Recipes



**[15 Bake only]** (SD-2501)

**[14 Bake only]** (SD-2500)  
Bake cakes and teabreads.

: Timer cannot be used

- Use menu 15 (SD-2500: 14) for these recipes.
- This menu is not suitable for all types of cake, such as Victoria sandwich or those that require going into a hot oven.
- Always use our tablespoon and teaspoon measure in these recipes.

The cake is made according to the recipe in a separate mixing bowl and then baked inside the bread pan.

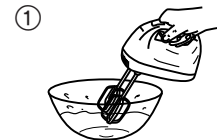

Mix the ingredients in a bowl.



Line the bottom and sides of the bread pan with baking parchment and pour in the mixture.

- Make sure that the kneading blade is removed from the bread pan before the cake mixture is added.
- Ensure that the cake mixture is kept inside the baking parchment.



Set the Bread Maker. (P. 18)

- The maximum baking time is 1 hour 30 mins.

## Apple and Ginger Cake

Menu '15' (SD-2500: '14') (1hr 5min)

Butter	100 g (4 oz)
Golden Syrup	200 g (8 oz)
Self Raising Flour	300 g (11 oz)
Baking Powder	3 mL (½ tsp)
Ground Cinnamon	3 mL (½ tsp)
Ground Cloves	3 mL (½ tsp)
Medium Sized Eggs, beaten	2
Tart Dessert Apples e.g. Granny Smiths, grated	2
Preserved Stem Ginger, drained and finely chopped	75 g (3 oz)
Demerara Sugar	1½ tbsp

- 1 Warm the butter and syrup until just melted. This can be done on the hob or in the microwave oven. (High power for 1 min).
- 2 Sieve the flour, baking powder and spices into a bowl. Add the syrup mixture and the beaten eggs.
- 3 Add the grated apple and the chopped ginger and mix well.
- 4 Remove the kneading blade from the bread pan and line the bottom and sides with baking parchment.
- 5 Place the mixture in the bread pan, being careful to ensure that the mixture is inside the baking parchment.
- 6 Carefully sprinkle the Demerara sugar on top of the mixture.
- 7 Select menu 15 (SD-2500: 14) and enter 1hr 5 mins on the timer.
- 8 After baking test with a skewer to see if the cake is cooked. If the cake does require extra time, select menu 15 (SD-2500: 14) again and enter a further 3–5 mins on the timer. If it is still just slightly sticky this will cook through during the stand period.
- 9 Take the bread pan out of the Bread Maker using oven gloves. Leave to stand for 5–10 mins before removing from the bread pan and allowing to cool.

## Banana and Walnut Loaf

Menu '15' (SD-2500: '14') (55min)

Soft Light Brown Sugar	50 g (2 oz)
Butter	75 g (3 oz)
Egg, medium	1
Plain Flour	225 g (8 oz)
Baking Powder	2 tsp
Grated Rind	1 lemon
Lemon Juice	1 tbsp
Medium Bananas, peeled & mashed	4
Walnuts, roughly chopped	50 g (2 oz)
Walnuts, finely chopped	15 g (½ oz)

- 1 Cream the butter and sugar together until soft then beat in the egg.
- 2 Add the sieved flour and baking powder together with the lemon rind and juice.
- 3 Add the mashed bananas and the roughly chopped walnuts and mix to a soft consistency.
- 4 Remove the kneading blade from the bread pan and line the bottom and sides with baking parchment.
- 5 Place the mixture in the bread pan, being careful to ensure that the mixture is inside the baking parchment.
- 6 Carefully sprinkle the finely chopped walnuts on top of the mixture.
- 7 Select menu 15 (SD-2500: 14) and enter 55 mins on the timer.
- 8 After baking test with a skewer to see if the cake is cooked. If the cake does require extra time, select menu 15 (SD-2500: 14) again and enter a further 3–5 mins on the timer. If it is still just slightly sticky this will cook through during the stand period.
- 9 Take the bread pan out of the Bread Maker using oven gloves. Leave to stand for 5–10 mins before removing from the bread pan and allowing to cool.

- Delicious spread with butter.

## Boozy Cake

Menu '15' (SD-2500: '14') (55min)

Butter	125 g (4 oz)
Mixed Dried Fruit	300 g (11 oz)
Light Brown Soft Sugar	50 g (2 oz)
Juice of 1 Orange	45 mL (3 tbsps)
Zest of 1 Orange	
Guinness® or Caffreys®	120 mL (4floz)
Bicarbonate of Soda	5 mL (1 tsp)
Medium Sized Eggs, beaten	2
Plain Flour	200 g (7 oz)
Mixed Spice	8 mL (1½ tsp)
Topping (flaked almonds)	15 g (½ oz)
Topping (demerara sugar)	15 g (½ oz)

- 1 Heat the butter, dried fruit, sugar, juice and zest of an orange and Guinness® together until the fruit plumps up. This can be done on the hob by bringing the ingredients to the boil, stirring and then simmering for 10–15 mins or heating in the microwave oven on High power for 8 mins, stirring twice.
- 2 Leave to cool for 10 mins, then stir in the bicarbonate of soda, this will make the mixture foam.
- 3 Stir in the eggs, flour and mixed spice, and mix well.
- 4 Remove the kneading blade from the bread pan and line the bottom and sides with baking parchment.
- 5 Place the mixture into the bread pan, being careful to ensure that the mixture is inside the baking parchment.
- 6 Sprinkle the flaked almonds and demerara on the top of the mixture.
- 7 Select menu 15 (SD-2500: 14) and enter 55 mins on the timer.
- 8 After baking test with a skewer to see if the cake is cooked. If the cake does require extra time, select menu 15 (SD-2500: 14) again and enter a further 3–5 mins on the timer. If it is still just slightly sticky this will cook through during the stand period.
- 9 Take the bread pan out of the Bread Maker using oven gloves. Leave to stand for 5–10 mins before removing from the bread pan and allowing to cool.

## Fruit Tea Bread

Menu '15' (SD-2500: '14') (1hr 15min)

Mixed Dried Fruit	350 g (12 oz)
Chopped Dates	50 g (2 oz)
Chopped Walnuts	50 g (2 oz)
Chopped Cherries	100 g (4 oz)
Strong tea	300 mL (10 floz)
Butter	75 g (3 oz)
Medium Sized Eggs, beaten	3
Plain Flour	250 g (9 oz)
Bicarbonate of Soda	5 mL (1 tsp)

- 1 Place the fruit, dates, walnuts, cherries, strong tea and butter together and heat until the fat has melted and the liquid is hot. This can be done on the hob or in the microwave oven. (High power for 3–4 mins)
- 2 Allow to cool slightly, then add eggs, flour and the bicarbonate of soda. Mix well.

- 3 Remove the kneading blade from the bread pan and line the bottom and sides with baking parchment.
- 4 Place the mixture into the bread pan, being careful to ensure that the mixture is inside the baking parchment.
- 5 Select menu 15 (SD-2500: 14) and enter 1hr 15 mins on the timer.
- 6 After baking test with a skewer to see if the cake is cooked. If the cake does require extra time, select menu 15 (SD-2500: 14) again and enter a further 3–5 mins on the timer. If it is still just slightly sticky this will cook through during the stand period.
- 7 Take the bread pan out of the Bread Maker using oven gloves. Leave to stand for 5–10 mins before removing from the bread pan and allowing to cool.

## Gingerbread

Menu '15' (SD-2500: '14') (45min)

Demerara Sugar	25 g (1 oz)
Butter	75 g (3 oz)
Golden Syrup	50 g (2 oz)
Black Treacle	75 g (3 oz)
Plain Flour	225 g (8 oz)
Ground Ginger	8 mL (1½ tsp)
Baking Powder	8 mL (1½ tsp)
Bicarbonate of Soda	3 mL (½ tsp)
Salt	3 mL (½ tsp)
Milk	150 mL (¼ pint)
Medium Sized Egg, beaten	1

- 1 Warm sugar, butter, golden syrup and treacle together until just melted. This can be done on the hob or in the microwave oven (High power for 1min).
- 2 Stir in all of the sieved dry ingredients.
- 3 Mix in the milk and the beaten egg.
- 4 Beat thoroughly with a wooden spoon.
- 5 Remove the kneading blade from the bread pan and line the bottom and sides with baking parchment.
- 6 Place the mixture into the bread pan, being careful to ensure that the mixture is inside the baking parchment.
- 7 Select menu 15 (SD-2500: 14) and enter 45 mins on the timer.
- 8 After baking test with a skewer to see if the cake is cooked. If the cake does require extra time, select menu 15 (SD-2500: 14) again and enter a further 3–5 mins on the timer. If it is still just slightly sticky this will cook through during the stand period.
- 9 Take the bread pan out of the Bread Maker using oven gloves. Leave to stand for 5–10 mins before removing from the bread pan and allowing to cool.

# Cake Recipes

## Hazelnut and Honey Loaf

Menu '15' (SD-2500: '14') (1hr)

Butter	175 g (6 oz)
Dark Brown Sugar	50 g (2 oz)
Honey	50 g (2 oz)
Eggs, medium	3
Hazelnuts, finely chopped	100 g (4 oz)
Self Raising Flour	225 g (8 oz)
Milk	60 mL (4 tbsp)
Topping (chocolate & hazelnut spread)	100 g (4 oz)
Topping (cream cheese)	50 g (2 oz)

- 1 Cream the butter, sugar and honey together until soft and fluffy.
- 2 Add the eggs one at a time, beating well after each addition. Stir in the hazelnuts.
- 3 Fold in the flour and mix to a soft consistency with the milk.
- 4 Remove the kneading blade from the bread pan and line the bottom and sides with baking parchment.
- 5 Place the mixture in the bread pan, being careful to ensure that the mixture is inside the baking parchment.
- 6 Select menu 15 (SD-2500: 14) and enter 1 hr on the timer.
- 7 After baking test with a skewer to see if the cake is cooked. If the cake does require extra time, select menu 15 (SD-2500: 14) again and enter a further 3–5 mins on the timer. If it is still just slightly sticky this will cook through during the stand period.
- 8 Take the bread pan out of the Bread Maker using oven gloves. Leave to stand for 5–10 mins before removing from the bread pan and allowing to cool.
- 9 Beat the chocolate spread and cream cheese together and spread on the top of the cooled loaf.

## Coffee & Pecan Nut Cake

Menu '15' (SD-2500: '14') (1hr)

Butter	225 g (8 oz)
Light Muscovado Sugar	100 g (4 oz)
Eggs, medium	3
Pecan Nuts, finely chopped	75 g (3 oz)
Self Raising Flour	225 g (8 oz)
Baking Powder	1 tsp
Strong Fresh Coffee	2-3 tbsp

### Optional Icing

Mascarpone Cheese	150 g (5 oz)
Icing Sugar	100 g (4 oz)
Strong Fresh Coffee	1 tbsp

- 1 Cream the butter and sugar together until soft and fluffy.
- 2 Add the eggs one at a time, beating well after each addition. Stir in the Pecan nuts.
- 3 Fold in the flour and baking powder, and mix to a soft consistency with the coffee.
- 4 Remove the kneading blade from the bread pan and line the bottom and sides with baking parchment.

5 Place the mixture in the bread pan, being careful to ensure that the mixture is inside the baking parchment.

6 Select menu 15 (SD-2500: 14) and enter 1 hr on the timer.

7 After baking test with a skewer to see if the cake is cooked. If the cake does require extra time, select menu 15 (SD-2500: 14) again and enter a further 3–5 mins on the timer. If it is still just slightly sticky this will cook through during the stand period.

8 Take the bread pan out of the Bread Maker using oven gloves. Leave to stand for 5–10 mins before removing from the bread pan and allowing to cool.

9 Beat the mascarpone cheese and icing sugar together with the coffee and spread on the top of the cooled loaf.

## Cherry & Marzipan Cake

Menu '15' (SD-2500: '14') (1hr)

Golden Caster Sugar	50 g (2 oz)
Butter	175 g (6 oz)
Eggs, medium	3
Self Raising Flour	225 g (8 oz)
Glace Cherries, chopped	100 g (4 oz)
Marzipan, grated	75 g (3 oz)
Milk	60 mL (4 tbsp)
Toasted, Flaked Almonds	15 g (½ oz)

- 1 Cream the butter and sugar together until soft then beat in the eggs, one at a time.
- 2 Add the flour with the cherries and grated marzipan, mix well with the milk to a soft consistency.
- 3 Remove the kneading blade from the bread pan and line the bottom and sides with baking parchment.
- 4 Place the mixture in the bread pan, being careful to ensure that the mixture is inside the baking parchment.
- 5 Carefully sprinkle the toasted almonds on top of the mixture.
- 6 Select menu 15 (SD-2500: 14) and enter 1hr on the timer.
- 7 After baking test with a skewer to see if the cake is cooked. If the cake does require extra time, select menu 15 (SD-2500: 14) again and enter a further 3–5 mins on the timer. If it is still just slightly sticky this will cook through during the stand period.
- 8 Take the bread pan out of the Bread Maker using oven gloves. Leave to stand for 5–10 mins before removing from the bread pan and allowing to cool.

## Soda Bread

Menu '15' (SD-2500: '14') (50min)

Plain Flour	400 g (14 oz)
Bicarbonate of Soda	1 tsp
Sugar	1 tsp
Salt	½ tsp
Buttermilk	270 mL
Milk	30 mL

- 1 Sieve the flour and bicarbonate of soda into a bowl and mix well. Then add sugar and salt.
- 2 Add the buttermilk and milk, mixing quickly to form a soft dough.
- 3 Remove the kneading blade from the bread pan and line the bottom and sides with baking parchment.
- 4 Place the mixture into the bread pan, being careful to ensure that the mixture is inside the baking parchment.
- 5 Select menu 15 (SD-2500: 14) and enter 50 mins on the timer.
- 6 After baking test with a skewer to see if the bread is cooked. If the bread does require extra time, select menu 15 (SD-2500: 14) again and enter a further 3–5 mins on the timer.
- 7 Remove the bread out of the bread pan using oven gloves and allow to cool.

## Wholemeal Soda Bread

Menu '15' (SD-2500: '14') (50min)

Self Raising Wholemeal Flour	400 g (14 oz)
Bicarbonate of Soda	1 tsp
Salt	1 tsp
Medium Sized Eggs, beaten	2
Buttermilk	320 mL

- 1 Place flour and bicarbonate of soda into a bowl and mix well. Then add salt.
- 2 Add the beaten eggs and buttermilk, mixing quickly to form a soft dough.
- 3 Remove the kneading blade from the bread pan and line the bottom and sides with baking parchment.
- 4 Place the mixture into the bread pan, being careful to ensure that the mixture is inside the baking parchment.
- 5 Select menu 15 (SD-2500: 14) and enter 50 mins on the timer.
- 6 After baking test with a skewer to see if the bread is cooked. If the bread does require extra time, select menu 15 (SD-2500: 14) again and enter a further 3–5 mins on the timer.
- 7 Remove the bread out of the bread pan using oven gloves and allow to cool.

## Yeast and Dairy Free Spelt Loaf

Menu '15' (SD-2500: '14') (50min)

Spelt Flour	400 g (14 oz)
Bicarbonate of Soda	1 tsp
Salt	1 tsp
Medium Sized Eggs, beaten	2
Soya milk	320 mL

- 1 Place flour and bicarbonate of soda into a bowl and mix well. Then add salt.
- 2 Add the beaten eggs and soya milk, mixing quickly to form a soft dough.
- 3 Remove the kneading blade from the bread pan and line the bottom and sides with baking parchment.
- 4 Place the mixture into the bread pan, being careful to ensure that the mixture is inside the baking parchment.
- 5 Select menu 15 (SD-2500: 14) and enter 50 mins on the timer.
- 6 After baking test with a skewer to see if the bread is cooked. If the bread does require extra time, select menu 15 (SD-2500: 14) again and enter a further 3–5 mins on the timer.
- 7 Remove the bread out of the bread pan using oven gloves and allow to cool.

## Cornbread

Menu '15' (SD-2500: '14') (55min)

Plain Flour	150 g (5 oz)
Fine Cornmeal or Polenta	150 g (5 oz)
Baking Powder	1 tbsp
Salt	1 tsp
Eggs, medium	2
Carton Buttermilk	284 mL
Milk	100 mL
Butter, melted and cooled	50 g (2 oz)

- 1 Combine flour, cornmeal, baking powder and salt into a bowl and mix well.
- 2 Beat the eggs with the buttermilk, milk and butter in another bowl.
- 3 Pour the egg mixture into the dry ingredients and stir to a smooth batter.
- 4 Remove the kneading blade from the bread pan and line the bottom and sides with baking parchment.
- 5 Place the mixture into the bread pan, being careful to ensure that the mixture is inside the baking parchment.
- 6 Select menu 15 (SD-2500: 14) and enter 55 mins on the timer.
- 7 After baking test with a skewer to see if the bread is cooked. If the bread does require extra time, select menu 15 (SD-2500: 14) again and enter a further 3–5 mins on the timer.
- 8 Remove the bread out of the bread pan using oven gloves and allow to cool.

# Jam Recipes

## [26 Jam] (SD-2501)

### [24 Jam] (SD-2500)

#### Strawberry Jam

Menu '26' (SD-2500: '24') (1hr 40min)

Strawberries, finely chopped	600 g (24 oz)
Sugar	400 g (16 oz)
Powdered Pectin	13 g (4 tsp)

- Place half of the fruit into the bread pan, then add half of the sugar. Repeat with the remaining fruit and sugar.
- Sprinkle the pectin onto the ingredients in the bread pan.
- Select menu 26 (SD-2500: 24) and enter 1hr 40min on the timer.

#### Blueberry Jam

Menu '26' (SD-2500: '24') (1hr 50min)

Blueberries	700 g (28 oz)
Sugar	400 g (16 oz)

- Place half of the fruit into the bread pan, then add half of the sugar. Repeat with the remaining fruit and sugar.
- Select menu 26 (SD-2500: 24) and enter 1hr 50min on the timer.

#### Apple and Blackberry jam

Menu '26' (SD-2500: '24') (1hr 40min)

Apples, grated or finely chopped	300 g (12 oz)
Blackberries	400 g (16 oz)
Sugar	300 g (12 oz)
Powdered Pectin	6 g (1½ tsp)

- Place half of the fruit into the bread pan, then add half of the sugar. Repeat with the remaining fruit and sugar.
- Sprinkle the pectin onto the ingredients in the bread pan.
- Select menu 26 (SD-2500: 24) and enter 1hr 40min on the timer.

#### Peach Melba

Menu '26' (SD-2500: '24') (1hr 40min)

Peaches, finely chopped	500 g (20 oz)
Raspberries	200 g (8 oz)
Sugar	300 g (12 oz)
Powdered Pectin	8 g (2¼ tsp)

- Place half of the fruit into the bread pan, then add half of the sugar. Repeat with the remaining fruit and sugar.
- Sprinkle the pectin onto the ingredients in the bread pan.
- Select menu 26 (SD-2500: 24) and enter 1hr 40min on the timer.

#### Plum Jam

Menu '26' (SD-2500: '24') (1hr 40min)

Plums, finely chopped	700 g (28 oz)
Sugar	350 g (14 oz)
Powdered Pectin	6 g (1¼ tsp)

- Place half of the fruit into the bread pan, then add half of the sugar. Repeat with the remaining fruit and sugar.
- Sprinkle the pectin onto the ingredients in the bread pan.
- Select menu 26 (SD-2500: 24) and enter 1hr 40min on the timer.

#### Frozen Berry Jam

Menu '26' (SD-2500: '24') (1hr 40min)

Frozen Mixed Berries	700 g (28 oz)
Sugar	400 g (14 oz)
Powdered Pectin	10 g (3 tsp)

- Place half of the fruit into the bread pan, then add half of the sugar. Repeat with the remaining fruit and sugar.
- Sprinkle the pectin onto the ingredients in the bread pan.
- Select menu 26 (SD-2500: 24) and enter 1hr 40min on the timer.

#### Redcurrant and Chilli Jam

Menu '26' (SD-2500: '24') (1hr 40min)

Redcurrants, roughly mashed	300 g (12 oz)
Medium Red Chilli, finely chopped	1-2
Root Ginger, finely grated	4 cm
Oranges, juice and finely grated zest	2
Sugar	150 g (6 oz)
Powdered Pectin	3 g (1 tsp)

- Place all the ingredients except sugar and pectin into the bread pan.
- Add the sugar and sprinkle the pectin onto the ingredients in the bread pan.
- Select menu 26 (SD-2500: 24) and enter 1hr 40min on the timer.

#### Apricot Jam

Menu '26' (SD-2500: '24') (1hr 30min)

Apricots, finely chopped	500 g (20 oz)
Sugar	250 g (10 oz)
Powdered Pectin	6 g (1¼ tsp)

- Place half of the fruit into the bread pan, then add half of the sugar. Repeat with the remaining fruit and sugar.
- Sprinkle the pectin onto the ingredients in the bread pan.
- Select menu 26 (SD-2500: 24) and enter 1hr 30min on the timer.

# Compote Recipes

## [27 Compote] (SD-2501)

### [25 Compote] (SD-2500)

#### Spiced Apple Compote

Menu '27' (SD-2500: '25') (1hr 20min)

Apples, peeled, cored and diced	1000 g (40 oz)
Cinnamon stick	1
Cloves	2
Lemon, zest only	1
Lemon Juice	2 tbsp
Sugar	100 g (4 oz)
Water	75 mL

- Remove the kneading blade from the bread pan.
- Place ingredients in the bread pan in the order listed above. Pour water over ingredients.
- Select menu 27 (SD-2500: 25) and enter 1hr 20min on the timer.
- Stir after cooking is completed.

#### Red fruits Compote

Menu '27' (SD-2500: '25') (1hr)

Plums, stone removed and cut in halves	300 g (12 oz)
Cherries, stone removed	250 g (10 oz)
Strawberries, stalk removed	250 g (10 oz)
Golden Caster Sugar	75 g (3 oz)
Water	75 mL
Raspberries (added after cooking)	200 g (8 oz)

- Remove the kneading blade from the bread pan.
- Place ingredients in the bread pan in the order listed above. Pour water over ingredients.
- Select menu 27 (SD-2500: 25) and enter 1hr on the timer.
- Stir after cooking is completed.
- Add raspberries.

#### Rhubarb and Ginger Compote

Menu '27' (SD-2500: '25') (1hr 40min)

Rhubarb, cut into 2 cm lengths	700 g (28 oz)
Orange Juice	2 tbsp
Crystallised Ginger, finely chopped	20 g (¾ oz)
Sugar	100 g (4 oz)
Water	100 mL

- Remove the kneading blade from the bread pan.
- Place ingredients in the bread pan in the order listed above. Pour water over ingredients.
- Select menu 27 (SD-2500: 25) and enter 1hr 40min on the timer.
- Stir after cooking is completed.

#### Mixed Berry Compote

Menu '27' (SD-2500: '25') (1hr)

Mixed Berries E.g. Strawberries, Raspberries, Blueberries	800 g (32 oz)
Sugar	75 g (3 oz)
Water	2 tbsp

- Remove the kneading blade from the bread pan.
- Place ingredients in the bread pan in the order listed above. Pour water over ingredients.
- Select menu 27 (SD-2500: 25) and enter 1hr on the timer.
- Stir after cooking is completed.

#### Apple sauce

Menu '27' (SD-2500: '25') (1hr 20min)

Bramley apples, peeled, cored and diced	1000 g (40 oz)
Water	2 tbsp

- Remove the kneading blade from the bread pan.
- Place the apple in the bread pan. Pour water over ingredients.
- Select menu 27 (SD-2500: 25) and enter 1hr 20min on the timer.
- Stir after cooking is completed.

#### Peach in Vanilla Syrup

Menu '27' (SD-2500: '25') (1hr)

Peaches, stone removed and cut into ½	1000 g (40 oz)
Sugar	100 g (4 oz)
Vanilla Pod	½
Water	125 mL

- Remove the kneading blade from the bread pan.
- Place ingredients in the bread pan in the order listed above. Pour water over ingredients.
- Select menu 27 (SD-2500: 25) and enter 1hr on the timer.
- When cooking is complete, remove the peaches with a slotted spoon. Carefully pour the syrup over the fruit. Leave to cool.

# Care & Cleaning

Before cleaning, unplug your Bread Maker and allow it to cool down.

■ To avoid damaging your Bread Maker...

- Do not use anything abrasive! (cleansers, scouring pads etc)  
Use a soft sponge when cleaning bread pan and kneading blade.
- Do not wash any part of your Bread Maker in the dishwasher!
- Do not use benzene, thinners, or alcohol!
- Keep your Bread Maker clean and dry.

## Bread pan & kneading blade

Twist the bread pan anti-clockwise to remove. Remove the kneading blade and wash in warm soapy water.



- Ensure the area around the shaft and inside the kneading blade are cleaned thoroughly.
- If the kneading blade is difficult to remove from the bread pan, place a small quantity of warm water into the bread pan and soak for 5–10 minutes. Do not submerge the bread pan in water.



## Measuring spoon & cup

Wash with water.

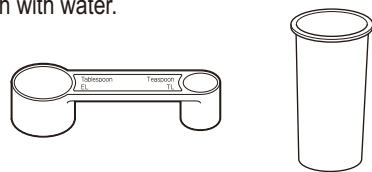

- Not dishwasher safe

## Lid

Wipe with a damp cloth.



## Steam vent

Wipe with a damp cloth.



## Body

Wipe with a damp cloth.

- Wipe gently to avoid damaging the temperature sensor.

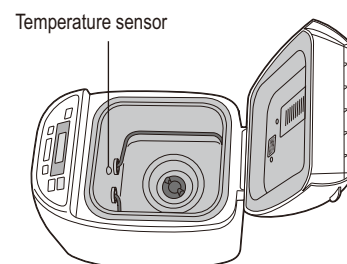

• The colour of the inside of the unit may change with use.

## Dispenser lid (SD-2501 only)

Remove and wash with water.

- Raise the dispenser lid to an angle of approximately 75 degrees. Align the connections and pull towards you to remove or push carefully back at the same angle to attach. (Wait until the machine has cooled down first, because it will be very hot immediately after use)
- Take care not to damage or pull the seal. (Damage could lead to leakage of steam, condensation, or deformation)



## Raisin nut dispenser (SD-2501 only)

(SD-2501 only)

Remove and wash with water.



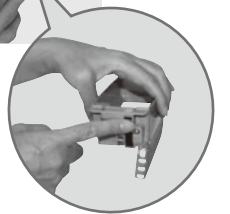

- Wash after each use to remove any residue.



# To protect the non-stick finish

Bread pan and kneading blade are coated with a non-stick finish to avoid stains and to make it easier to remove bread.

To avoid damaging it, please follow the instructions below.

- Do not use hard utensils such as a knife or a fork when removing the bread from the bread pan. When you have hard time taking out the bread from the bread pan, see P. 46. 
- Ensure that the kneading blade is not embedded in the bread loaf before slicing it. If it is embedded, wait for the loaf to cool and remove it. In removing the kneading blade, press on the base of the loaf and manipulate the kneading blade gently to avoid damaging the loaf. (Do not use hard or sharp utensils such as a knife or a fork.) Be careful not to get burns as the kneading blade may still be hot. 
- Use the soft sponge when cleaning the bread pan and the kneading blade. Do not use anything abrasive such as cleansers or scouring pads. 
- Hard, coarse or large ingredients such as flours with whole or ground grains, sugar, or the addition of nuts and seeds may damage the non-stick finish of the bread pan. If using large chunk of ingredient, break into small pieces. Please make sure to follow the recipe quantities stated.

# Troubleshooting

Before calling for service, please check through this section.

Problem	Cause → Action
My bread does not rise.	<p>[All bread]</p> <ul style="list-style-type: none"> <li>The quality of the gluten in your flour is poor, or you have not used strong flour. (Gluten quality can vary depending on temperature, humidity, how the flour is stored, and the season of harvest)           <ul style="list-style-type: none"> <li>→ Try another type, brand or another batch of flour.</li> </ul> </li> <li>The dough has become too firm because you haven't used enough liquid.           <ul style="list-style-type: none"> <li>→ Stronger, Organic and Stoneground flour with higher protein content absorbs more water than others, so try adding an extra 10–20 mL of water.</li> </ul> </li> <li>You are not using the right type of yeast.           <ul style="list-style-type: none"> <li>→ Use dry yeast from a sachet, which has 'Easy Blend', 'Fast Action' or 'Easy Bake' written on it. This type does not require pre-fermentation.</li> </ul> </li> <li>You are not using enough yeast, or your yeast is old.           <ul style="list-style-type: none"> <li>Make sure yeast sachets not open for longer than 48 hours.</li> <li>→ Use the measuring spoon provided. Check the yeast's expiry date.</li> </ul> </li> <li>The yeast has touched the liquid before kneading.           <ul style="list-style-type: none"> <li>→ Check that you have put in the ingredients in the correct order according to the instructions. (P. 12)</li> </ul> </li> <li>You have used too much salt, or not enough sugar.           <ul style="list-style-type: none"> <li>→ Check the recipe and measure out the correct amounts using the measuring spoon provided.</li> <li>→ Check that salt and sugar is not included in other ingredients.</li> </ul> </li> </ul> <p>[Speciality bread]</p> <ul style="list-style-type: none"> <li>Einkorn wheat was used when baking speciality bread and/or a lot of flour other than spelt flour were used.           <ul style="list-style-type: none"> <li>→ The spelt flour should be up to 60% of the entire flour when you use more than two kinds of flour other than spelt. The rye and the rice flour should be up to 40% of the entire flour and buckwheat flour should be up to 20% of the entire flour.</li> </ul> </li> </ul>
The top of my bread is uneven.	
My bread is full of air holes.	<ul style="list-style-type: none"> <li>You have used too much yeast.           <ul style="list-style-type: none"> <li>→ Check the recipe and measure out the correct amount using the measuring spoon provided.</li> </ul> </li> <li>You have used too much liquid.           <ul style="list-style-type: none"> <li>→ Some types of flour absorb more water than others, so try using 10–20 mL less water.</li> </ul> </li> </ul>
My bread seems to have collapsed after rising.	<ul style="list-style-type: none"> <li>The quality of your flour isn't very good.           <ul style="list-style-type: none"> <li>→ Try using a different brand of flour.</li> </ul> </li> <li>You have used too much liquid.           <ul style="list-style-type: none"> <li>→ Try using 10–20 mL less water.</li> </ul> </li> </ul>
My bread has risen too much.	<ul style="list-style-type: none"> <li>You have used too much yeast/water.           <ul style="list-style-type: none"> <li>→ Check the recipe and measure out the correct amount using the measuring spoon (yeast)/ cup (water) provided.</li> <li>→ Check that excess water amount is not included in other ingredients.</li> </ul> </li> <li>You have not used enough flour.           <ul style="list-style-type: none"> <li>→ Carefully weigh the flour using scales.</li> </ul> </li> </ul>
Why is my bread pale and sticky?	<ul style="list-style-type: none"> <li>You are not using enough yeast, or your yeast is old.           <ul style="list-style-type: none"> <li>→ Use the measuring spoon provided. Check the yeast's expiry date.</li> </ul> </li> <li>There has been a power failure, or the machine has been stopped during breadmaking.           <ul style="list-style-type: none"> <li>→ The machine switches off if it is stopped for more than 10 minutes. You will need to remove the bread from the bread pan and start again with new ingredients.</li> </ul> </li> </ul>

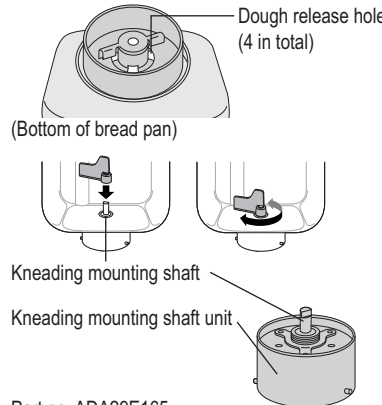
Problem	Cause → Action
There is excess flour around the bottom and sides of my bread.	<ul style="list-style-type: none"> <li>You have used too much flour, or you are not using enough liquid.           <ul style="list-style-type: none"> <li>→ Check the recipe and measure out the correct amount using scales for the flour or the measuring cup provided for liquids.</li> </ul> </li> </ul>
Why has my bread not mixed properly?	<ul style="list-style-type: none"> <li>You haven't put the kneading blade in the bread pan.           <ul style="list-style-type: none"> <li>→ Make sure the kneading blade is in the bread pan before you put in the ingredients.</li> </ul> </li> <li>There has been a power failure, or the machine has been stopped during breadmaking.           <ul style="list-style-type: none"> <li>→ The machine switches off if it is stopped for more than 10 minutes. You might be able to start the loaf again, though this might give poor results if kneading had already begun.</li> </ul> </li> <li>The kneading mounting shaft in the bread pan is stiff and does not rotate.           <ul style="list-style-type: none"> <li>→ If the kneading mounting shaft does not rotate when the blade is attached, you will need to replace the kneading mounting shaft unit (consult the place of purchase or a Panasonic service centre: 0844 8443868 or order online at <a href="http://www.panasonic.co.uk">www.panasonic.co.uk</a>).</li> </ul> </li> </ul>
My bread has not been baked.	<ul style="list-style-type: none"> <li>The dough menu was selected.           <ul style="list-style-type: none"> <li>→ The dough menu does not include a baking process.</li> </ul> </li> <li>There has been a power failure, or the machine has been stopped during breadmaking.           <ul style="list-style-type: none"> <li>→ The machine switches off if it is stopped for more than 10 minutes. You can try baking the dough in your oven if it has risen and proved.</li> </ul> </li> <li>There is not enough water and the motor protection device has activated. This only happens when the unit is overloaded and excessive force is applied to the motor.           <ul style="list-style-type: none"> <li>→ Visit place of purchase for a service consultation. Next time, check the recipe and measure out the correct amount using the measuring cup provided for liquid and scales for weighing flour.</li> </ul> </li> </ul>
Dough leaks out of the bottom of the bread pan.	<ul style="list-style-type: none"> <li>A small amount of dough will escape through the four holes (so that it does not stop the rotating parts from rotating). This is not a fault, but check occasionally that the kneading mounting shaft rotate properly.           <ul style="list-style-type: none"> <li>→ If the kneading mounting shaft does not rotate when the kneading blade is attached, you will need to replace the kneading mounting shaft unit (consult the place of purchase or a Panasonic service centre: 0844 8443868 or order online at <a href="http://www.panasonic.co.uk">www.panasonic.co.uk</a>).</li> </ul> </li> </ul> 
The sides of my bread have collapsed and the bottom is damp.	<ul style="list-style-type: none"> <li>You have left the bread in the bread pan for too long after baking.           <ul style="list-style-type: none"> <li>→ Remove the bread promptly after baking.</li> </ul> </li> <li>There has been a power failure, or the machine has been stopped during breadmaking.           <ul style="list-style-type: none"> <li>→ The machine switches off if it is stopped for more than 10 minutes. You may try baking the dough in your oven.</li> </ul> </li> </ul>
The kneading blade rattles.	<ul style="list-style-type: none"> <li>This is because the kneading blade fits loosely on the kneading mounting shaft. (This is not a fault)</li> </ul>

# Troubleshooting

Before calling for service, please check through this section.

Problem	Cause → Action
<p>I can smell burning while the bread is baking.</p> <p>Smoke is coming out of the steam vent.</p>	<ul style="list-style-type: none"> <li>● Ingredients may have been spilt on the heating element.           <ul style="list-style-type: none"> <li>→ Sometimes a little flour, raisins or other ingredients may be flicked out of the bread pan during mixing. Simply wipe the heating element gently after baking once the Bread Maker has cooled down.</li> <li>→ Remove the bread pan from the Bread Maker to place ingredients.</li> </ul> </li> </ul>
<p>The kneading blade stays in the bread when I remove it from the bread pan.</p>	<ul style="list-style-type: none"> <li>● The dough is a little stiff.           <ul style="list-style-type: none"> <li>→ Allow the bread to cool completely before removing the kneading blade carefully. Some types of flour absorb more water than others, so try adding an extra 10–20 mL of water next time.</li> </ul> </li> <li>● Crust has built up underneath the kneading blade.           <ul style="list-style-type: none"> <li>→ Wash the kneading blade and its spindle after each use.</li> </ul> </li> </ul>
<p>The crust creases and goes soft on cooling.</p>	<ul style="list-style-type: none"> <li>● The steam remaining in the bread after baking can pass into the crust and soften it slightly.           <ul style="list-style-type: none"> <li>→ To reduce the amount of steam, try using 10–20 mL less water.</li> <li>→ Remove loaf from the bread pan immediately after baking completed.</li> </ul> </li> </ul>
<p>How can I keep my crust crispy?</p>	<ul style="list-style-type: none"> <li>● To make your bread crispier, you could use menu 08 (SD-2500: 07) or the 'Dark' crust colour option, or even bake it in the oven at 200°C/gas mark 6 for an extra 5–10 minutes.</li> </ul>
<p>My bread is sticky and slices unevenly.</p>	<ul style="list-style-type: none"> <li>● It was too hot when you sliced it.           <ul style="list-style-type: none"> <li>→ Allow your bread to cool on rack before slicing to release the steam.</li> </ul> </li> </ul>
<p>Extra ingredients are not mixed properly in brioche.</p>	<ul style="list-style-type: none"> <li>● Did you add extra ingredients within 5 min of the beep?           <ul style="list-style-type: none"> <li>→ Butter must be added while '👏' is flashing in the display</li> </ul> </li> </ul>
<p>There is excess oil on the bottom of brioche. The crust is oily. My bread has big holes.</p>	<ul style="list-style-type: none"> <li>● Did you add butter within 5 min of the beep?           <ul style="list-style-type: none"> <li>→ Butter must be added while '👏' is flashing in the display.</li> </ul> </li> </ul>
<p>The bread does not come out.</p>	<ul style="list-style-type: none"> <li>● If the bread cannot be easily removed from the bread pan, leave the bread pan for 5–10 minutes to cool, making sure that it is not left unattended where somebody or something may get burnt. After that, shake the pan several times using oven gloves. (Hold the handle down so that it does not get in the way of bread.)</li> </ul>
<p>When cooking jam, it has scorched or the kneading blade fixes and it doesn't come off.</p>	<ul style="list-style-type: none"> <li>● The amount of the fruit was a too little, or the amount of sugar is too much.           <ul style="list-style-type: none"> <li>→ Place the bread pan in the sink and half fill the bread pan with warm water. Leave the bread pan to soak until the cooked on mixture or kneading blade loosens. After scorching is relieved, wash it with a soft sponge etc. Please be aware of the hot water.</li> </ul> </li> </ul>
<p>The jam has boiled over.</p>	<ul style="list-style-type: none"> <li>● Too much fruit or sugar has been used.           <ul style="list-style-type: none"> <li>→ Only use the amounts of fruit and sugar specified in the recipes on P. 40.</li> </ul> </li> </ul>
<p>Jam is too runny and not firmly set.</p>	<ul style="list-style-type: none"> <li>● The fruit was under or over ripe.</li> <li>● Sugar was decreased too much.</li> <li>● Cooking time was insufficient.</li> <li>● Fruit with a low pectin content was used.           <ul style="list-style-type: none"> <li>→ Use the runny jam as a sauce for desserts.</li> <li>→ Leave the jam to cool completely. The jam will continue to set as it cools.</li> </ul> </li> </ul>

Problem	Cause → Action
<p>Can frozen fruits be used?</p>	<ul style="list-style-type: none"> <li>● It is possible to use them.</li> </ul>
<p>What kinds of sugar can we use on jam?</p>	<ul style="list-style-type: none"> <li>● White caster and granulated can be used. Do not use brown sugar, diet sugar, and low calorie sugar or artificial sweetener.</li> </ul>
<p>When making jam, can we use fruits are pickled in alcohol?</p>	<ul style="list-style-type: none"> <li>● Do not use them. The quality is not satisfactory.</li> </ul>
<p>The fruit has collapsed when making fruit in syrup.</p>	<ul style="list-style-type: none"> <li>● The cooking time was too long. The fruit may have been over ripe.</li> </ul>
<p>⚡ appears on the display.</p>	<ul style="list-style-type: none"> <li>● There has been a power failure for approx. 10 minutes (the plug has been accidentally pulled out, or the breaker has been activated), or there is another problem with the power supply.           <ul style="list-style-type: none"> <li>→ The operation will not be affected if the problem with the power supply is only momentary. The Bread Maker will operate again if its power is restored within 10 minutes, but the end result may be affected.</li> </ul> </li> </ul>
<p>01 appears on the display.</p>	<ul style="list-style-type: none"> <li>● There has been a power failure for a certain amount of time (differs depending on the circumstances-e.g. mains power failure, unplugging, malfunctioning fuse or breaker).           <ul style="list-style-type: none"> <li>→ Remove the ingredients and start again using new.</li> </ul> </li> </ul>
<p>H01–H02 appears on the display.</p>	<ul style="list-style-type: none"> <li>● The display indicates a problem with the Bread Maker.           <ul style="list-style-type: none"> <li>→ Consult the place of purchase or a Panasonic service centre: 0844 8443868</li> </ul> </li> </ul>
<p>U50 appears on the display.</p>	<ul style="list-style-type: none"> <li>● The unit is hot (above 40°C/105°F).           <ul style="list-style-type: none"> <li>→ Allow the unit to cool down to below 40°C/105°F before using it again (U50 will disappear).</li> </ul> </li> </ul>